



HY11P36
Datasheet
8-Bit RISC-like Mixed Signal Microcontroller
Embedded 4x32 LCD Driver
18-Bit Σ ADC

目錄

1.	特點.....	5
2.	引腳定義.....	6
2.1	HY11P36 LQFP64 引腳圖.....	6
2.2	HY11P36 I/O 定義與說明	7
3.	應用電路.....	10
3.1	橋式感測器 I	10
4.	功能概述.....	11
4.1	內部方塊圖	11
4.2	相關說明與支援文件.....	12
4.3	SD18 Network.....	13
5.	暫存器列表.....	14
6.	電氣特性.....	16
6.1	Recommended operating conditions.....	16
6.2	Internal RC Oscillator	17
6.3	Supply current into VDD excluding peripherals current.....	18
6.4	Port1~2.....	20
6.5	Reset(Brownout, External RST pin, Low Voltage Detect)	21

HY11P36

Embedded 18-Bit $\Sigma\Delta$ ADC 8-Bit RISC-like Mixed Signal Microcontroller



6.6	Power System.....	23
6.7	LCD	25
6.8	SD18,Power Supply and recommended operating conditions	26
6.8.1	PGA,Power Supply and recommended operating conditions	26
6.8.2	SD18,performance II (fSD18=250KHz)	26
6.8.3	SD18 Noise Performance	28
6.9	Build-In EPROM(BIE)	30
7.	訂貨資訊.....	31
8.	封裝型式資訊	32
8.1	LQFP64(L064)	32
9.	修訂記錄.....	33

注意：

- 1、本說明書中的內容，隨著產品的改進，有可能不經過預告而更改。請客戶及時到本公司網站下載更新 <http://www.hycontek.com>
- 2、本規格書中的圖形、應用電路等，因第三方工業所有權引發的問題，本公司不承擔其責任。
- 3、本產品在單獨應用的情況下，本公司保證它的性能、典型應用和功能符合說明書中的條件。當使用在客戶的產品或設備中，以上條件我們不作保證，建議客戶做充分的評估和測試。
- 4、請注意輸入電壓、輸出電壓、負載電流的使用條件，使 IC 內的功耗不超過封裝的容許功耗。對於客戶在超出說明書中規定額定值使用產品，即使是瞬間的使用，由此所造成的損失，本公司不承擔任何責任。
- 5、本產品雖內置防靜電保護電路，但請不要施加超過保護電路性能的過大靜電。
- 6、本規格書中的產品，未經書面許可，不可使用在要求高可靠性的電路中。例如健康醫療器械、防災器械、車輛器械、車載器械及航空器械等對人體產生影響的器械或裝置，不得作為其部件使用。
- 7、本公司一直致力於提高產品的品質和可靠度，但所有的半導體產品都有一定的失效概率，這些失效概率可能會導致一些人身事故、火災事故等。當設計產品時，請充分留意冗餘設計，採用安全指標，這樣可以避免事故的發生。
- 8、本規格書中內容，未經本公司許可，嚴禁用於其他目的之轉載或複製。

1. 特點

- 8 位元加強型精簡指令集，共有 66 個指令
包含硬體乘法指令及查表指令
- 2.2V to 3.6V 工作電壓範圍，-40~85°C 工作溫度範圍。
- 外部石英震盪器及內部高精度 RC 震盪器，6 種 CPU 工作時脈切換選擇，可讓使用者達到最佳省電規劃
 - 運行模式 300uA@2MHz
 - 待機模式 3uA@28KHz
 - 休眠模式 1uA
- 4KWord OTP (One Time Programmable) Type 程式記憶體，256Byte 資料記憶體
- Brownout detector 及 Watch dog Timer，可防止 CPU 進入死機模式。
- 18bit 全差動輸入 $\Sigma\Delta$ ADC 類比數位轉換器
 - 內置 PGA (Programmable Gain Amplifier) 及可有 1/4、1/2、1、.....128 倍多種輸入信號放大倍率選擇
 - 內置輸入零點調整，可針對不同應用增加其量測範圍
- 可選擇不同的數據輸出速率，最高可達 1.95ksps
- 1.0V 的內部類比電路共地電壓源，具有 Push-Pull 驅動能力，可提供傳感器驅動電壓
- LVD 低電壓檢測功能具 14 段檢測電壓設置與外部輸入電壓檢測功能
- 類比電壓源 VDDA 具 10mA 穩壓電壓源輸出能力
- 4x32 LCD 液晶驅動器
 - 1/4 Duty、1/3 Bias
 - 內建 Charge Pump 穩壓線路，可提供 4 種 LCD 偏壓
- 8-bit Timer A
- 8-bit Timer C 模組具 PWM/PFD 波形產生功能
- Built-In EPROM (BIE)
- Support 6 stack level.

HY11P36

Embedded 18-Bit $\Sigma\Delta$ ADC
8-Bit RISC-like Mixed Signal Microcontroller

引腳定義

2.1 HY11P36 LQFP64 引腳圖



圖 2-1 HY11P36 LQFP64 引腳圖

註 1 : VPP 與 RST 復用同一接口，非燒錄 EPROM 時禁止輸入電壓超過 5.8V

註 2 : TST 與 PT1.3 復用同一接口，操作時禁止輸入電壓超過 VDD+0.3V

註 3 : 若不將 PT1.3 設定成外部引腳按鍵，可以提升抗干擾能力

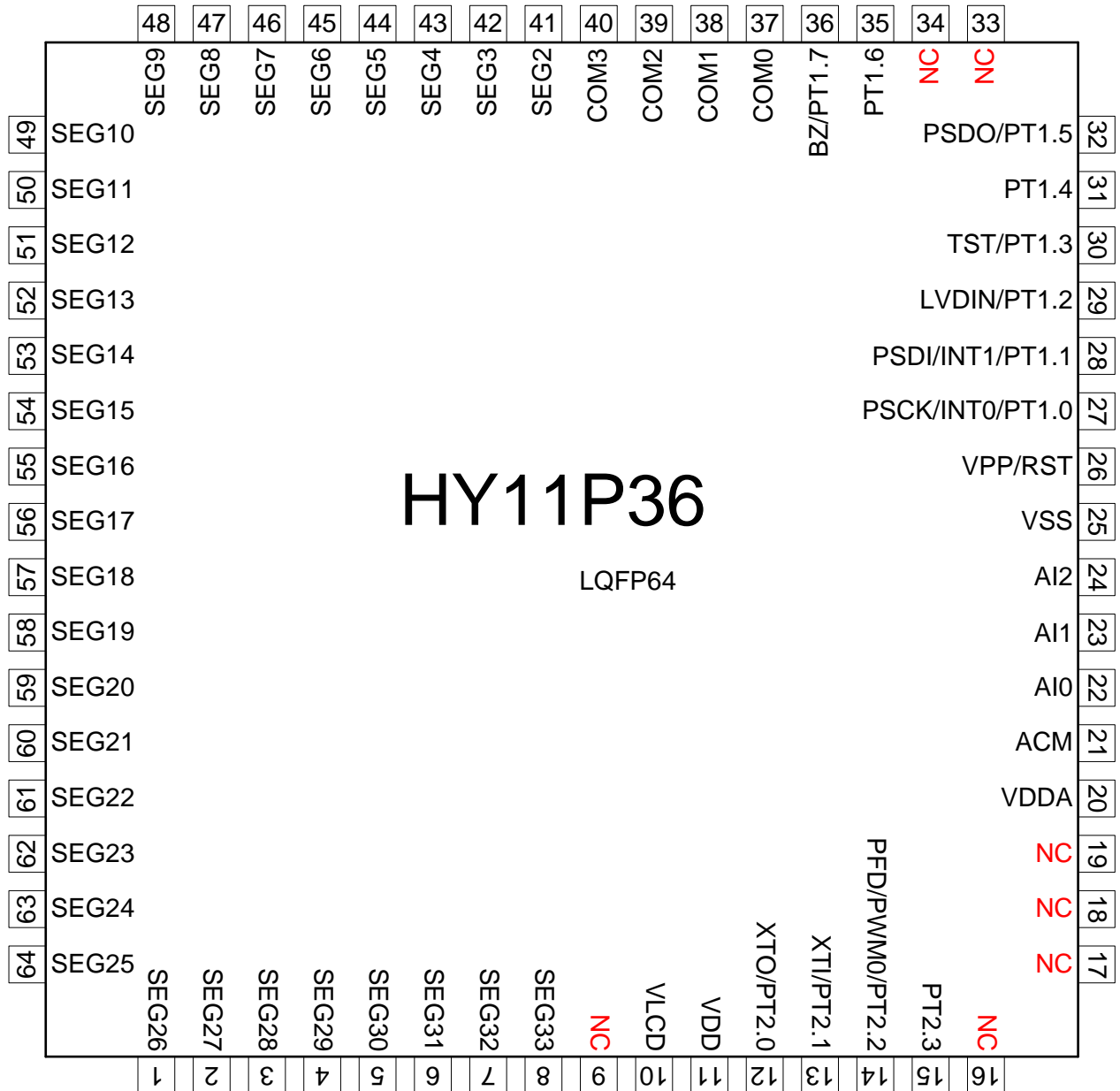
2.2 HY11P36 I/O 定義與說明

“I/O”輸入/輸出,“I”輸入,“O”輸出,“S”史密斯觸發,“C”CMOS 特性兼容輸出與輸入,“P”電壓源,“A”類比通道

編號	引腳名稱		引腳特性		功能說明
	HY11P36		緩衝	緩衝	
1	SEG26		O	A	LCD 的 Segment 輸出
2	SEG27		O	A	LCD 的 Segment 輸出
3	SEG28		O	A	LCD 的 Segment 輸出
4	SEG29		O	A	LCD 的 Segment 輸出
5	SEG30		O	A	LCD 的 Segment 輸出
6	SEG31		O	A	LCD 的 Segment 輸出
7	SEG32		O	A	LCD 的 Segment 輸出
8	SEG33		O	A	LCD 的 Segment 輸出
9	NC		-	-	未使用
10	VLCD		P	P	LCD 的電壓源
11	VDD		P	P	晶片工作電壓源
12	PT2.0/XTO	PT2.0	I/O	S	數位輸入/輸出
		XTO	A	A	外接振盪器輸出端
13	PT2.1/XTI	PT2.1	I/O	S	數位輸入/輸出
		XTI	A	A	外接振盪器輸入端
14	PT2.2/PWM0/PFD	PT2.2	I/O	C	數位輸入/輸出
		PWM0	O	C	PWM 輸出接口
		PFD	O	C	PFD 輸出接口
15	PT2.3	PT2.3	I/O	S	數位輸入/輸出
16	NC		-	-	未使用
17	NC		-	-	未使用
18	NC		-	-	未使用
19	NC		-	-	未使用
20	VDDA		P	P	穩壓器輸出·類比電路電壓源
21	ACM		P	P	內部類比電路共地引腳
22	AI0		A	A	類比輸入通道
23	AI1		A	A	類比輸入通道
24	AI2		A	A	類比輸入通道

HY11P36

Embedded 18-Bit Σ ADC 8-Bit RISC-like Mixed Signal Microcontroller

25	VSS		P	P	晶片工作電壓源接地端
26	RST/VPP	RST	I	S	復位晶片
		VPP	P	P	EPROM 讀/寫時的電壓源
27	PT1.0/INT0/PSCK	PT1.0	I	S	數位輸入
		INT0	I	S	中斷源 INT0
		PSCK	I	S	OTP 讀/寫介面 SCK 接口
28	PT1.1/INT1/PSDI	PT1.1	I	S	數位輸入
		INT1	I	S	中斷源 INT1
		PSDI	I	S	OTP 讀/寫介面 SDI 接口
29	PT1.2/LVDIN	PT1.2	I	S	數位輸入
		LVDIN	A	A	LVD 外部信號輸入接口
30	PT1.3/TST	PT1.3	I	S	數位輸入
		TST	I	S	測試模式致能輸入 (未開放)
31	PT1.4		I/O	S	數位輸入/輸出
32	PT1.5/PSDO	PT1.5	I/O	S	數位輸入/輸出
		PSDO	O	C	OTP 讀/寫介面 SDO 接口
33	NC		-	-	未使用
34	NC		-	-	未使用
35	PT1.6				
		PT1.6	I/O	S	數位輸入/輸出
36	PT1.7/BZ				
		PT1.7	I/O	S	數位輸入/輸出
		BZ	O	C	蜂鳴器輸出端
37	COM0		O	A	LCD 的 COM 輸出
38	COM1		O	A	LCD 的 COM 輸出
39	COM2		O	A	LCD 的 COM 輸出
40	COM3		O	A	LCD 的 COM 輸出
41	SEG2		O	A	LCD 的 Segment 輸出
42	SEG3		O	A	LCD 的 Segment 輸出
43	SEG4		O	A	LCD 的 Segment 輸出
44	SEG5		O	A	LCD 的 Segment 輸出

HY11P36

Embedded 18-Bit $\Sigma\Delta$ ADC 8-Bit RISC-like Mixed Signal Microcontroller

45	SEG6	O	A	LCD 的 Segment 輸出
46	SEG7	O	A	LCD 的 Segment 輸出
47	SEG8	O	A	LCD 的 Segment 輸出
48	SEG9	O	A	LCD 的 Segment 輸出
49	SEG10	O	A	LCD 的 Segment 輸出
50	SEG11	O	A	LCD 的 Segment 輸出
51	SEG12	O	A	LCD 的 Segment 輸出
52	SEG13	O	A	LCD 的 Segment 輸出
53	SEG14	O	A	LCD 的 Segment 輸出
54	SEG15	O	A	LCD 的 Segment 輸出
55	SEG16	O	A	LCD 的 Segment 輸出
56	SEG17	O	A	LCD 的 Segment 輸出
57	SEG18	O	A	LCD 的 Segment 輸出
58	SEG19	O	A	LCD 的 Segment 輸出
59	SEG20	O	A	LCD 的 Segment 輸出
60	SEG21	O	A	LCD 的 Segment 輸出
61	SEG22	O	A	LCD 的 Segment 輸出
62	SEG23	O	A	LCD 的 Segment 輸出
63	SEG24	O	A	LCD 的 Segment 輸出
64	SEG25	O	A	LCD 的 Segment 輸出

表 2-1 引腳定義與功能說明

HY11P36

Embedded 18-Bit $\Sigma\Delta$ ADC
8-Bit RISC-like Mixed Signal Microcontroller

2. 應用電路

2.1 橋式感測器 I



圖 3-1 橋式感測器應用電路

註：Load Cell 零點電壓位置可透過 DCSET[2:0] 進行偏壓調整。

3. 功能概述

3.1 内部方块图

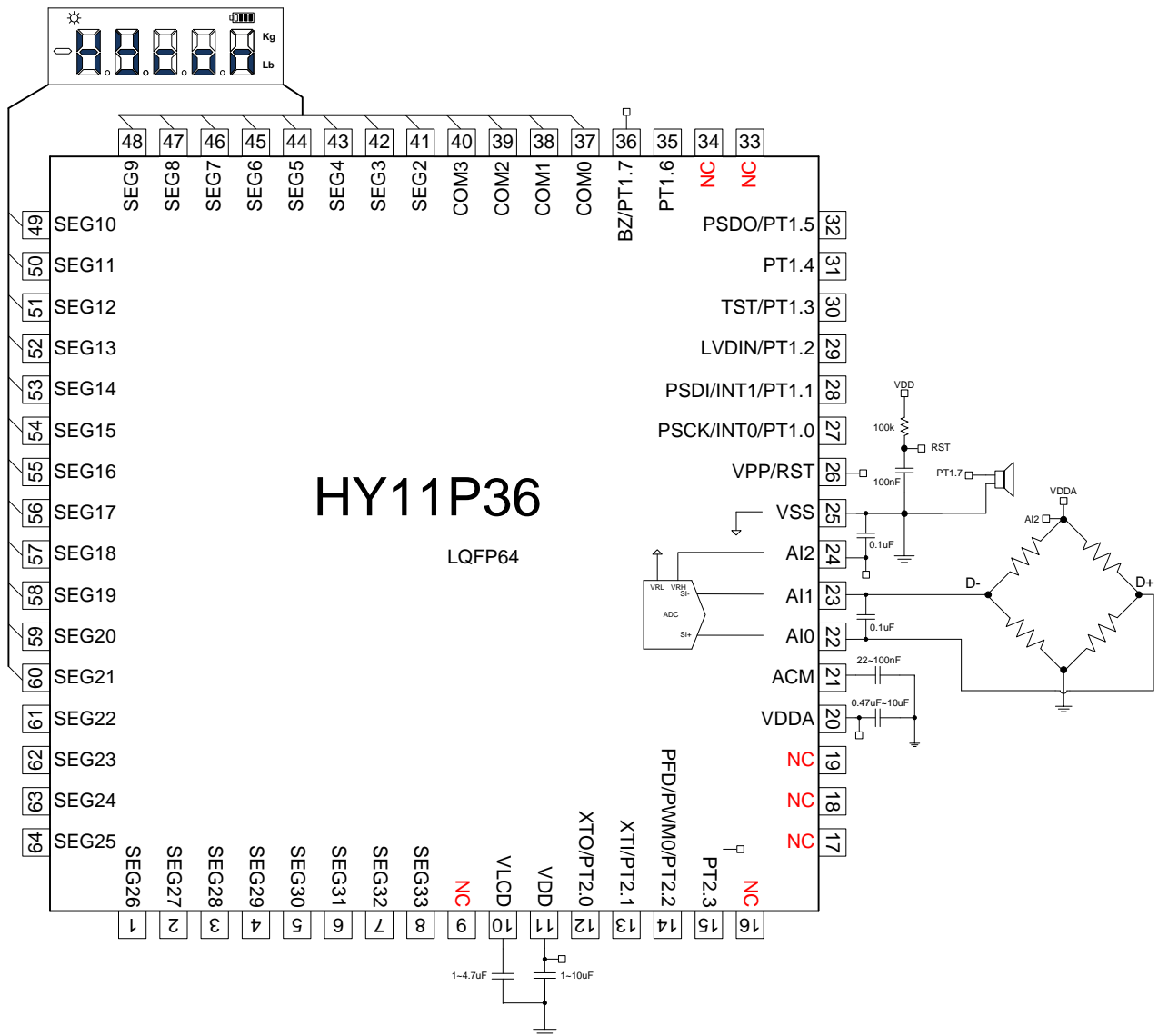
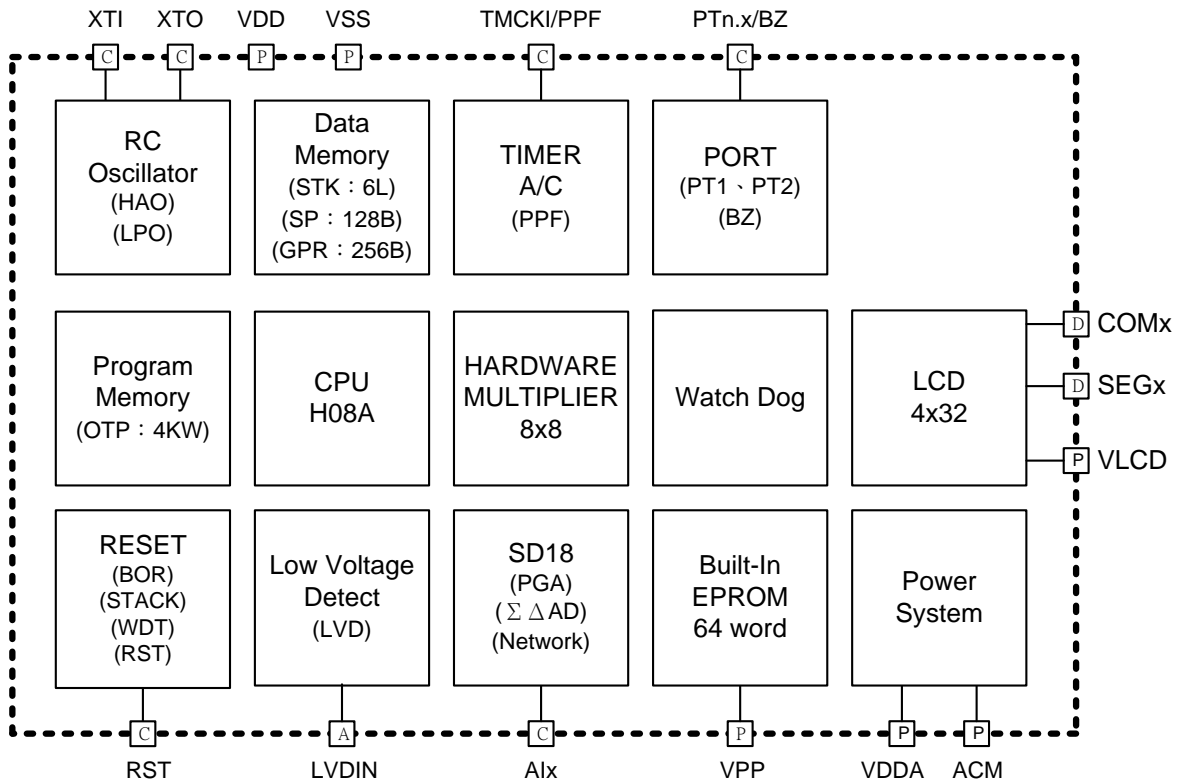

P Power Pad
 D Digital Pad
 A Analog Pad
 C Common I/O Pad

圖 4-1 HY11P36 内部方块图

3.2 相關說明與支援文件

晶片功能相關使用說明書

DS-HY11P36-Vxx	HY11P36 說明書
UG-HY11S14-Vxx	HY11Pxx 系列使用說明書
APD-CORE002-Vxx	H08A 指令說明書

開發工具相關使用說明書

APD-HYIDE006-Vxx	HY11xxx 系列開發工具軟體使用說明書
APD-HYIDE005-Vxx	HY11xxx 系列開發工具硬體使用說明書
APD-OTP001-Vxx	OTP 產品燒錄引腳說明書

產品生產相關使用說明書

APD-HYIDE004-Vxx	HY1xxxx 系列生產線專用燒錄器說明書
BDI-HY11P36-Vxx	HY11P36 個別產品的裸片打線資訊

3.3 SD18 Network



圖 4-2 SD18 Network

4. 暫存器列表

"r"no use,"w"read/write,"w"write,"r"read,"r0"only read 0,"r1"only read 1,"w0"only write 0,"w1"only write 1 "u"unimplemented bit,"x"unknown,"u"unchanged,"d"depends on condition																			
Address	File Name	Bit7	Bit6	Bit5	Bit4	Bit3	Bit2	Bit1	Bit0	A-RESET	i-RESET	R/W							
00H	INDF0	Contents of FSR0 to address data memory value of FSR0 not changed								N/A	N/A	*****							
01H	POINC0	Contents of FSR0 to address data memory value of FSR0 post-incremented								N/A	N/A	*****							
02H	PODEC0	Contents of FSR0 to address data memory value of FSR0 post-decremented								N/A	N/A	*****							
03H	PRINC0	Contents of FSR0 to address data memory value of FSR0 pre-incremented								N/A	N/A	*****							
04H	PLUSW0	Contents of FSR0 to address data memory value of FSR0 offset by W								N/A	N/A	*****							
05H	INDF1	Contents of FSR1 to address data memory value of FSR0 not changed								N/A	N/A	*****							
06H	POINC1	Contents of FSR1 to address data memory value of FSR0 post-incremented								N/A	N/A	*****							
07H	PODEC1	Contents of FSR1 to address data memory value of FSR0 post-decremented								N/A	N/A	*****							
08H	PRINC1	Contents of FSR1 to address data memory value of FSR0 pre-incremented								N/A	N/A	*****							
09H	PLUSW1	Contents of FSR1 to address data memory value of FSR0 offset by W								N/A	N/A	*****							
0FH	FSR0H									FSR0[8]xu	*****						
10H	FSR0L	Indirect Data Memory Address Pointer 0 Low Byte,FSR0[7:0]								xxxx xxxx	uuuu uuuu	*****							
11H	FSR1H									FSR1[8]xu	*****						
12H	FSR1L	Indirect Data Memory Address Pointer 1 Low Byte,FSR1[7:0]								xxxx xxxx	uuuu uuuu	*****							
16H	TOSH					TOS[11]	TOS[10]	TOS[9]	TOS[8]00000000	*****							
17H	TOSL	Top-of-Stack Low Byte (TOS<7:0>)											0000 0000	0000 0000	*****				
18H	STKPTR	STKFL	STKUN	STKOV					STKPR[2:0]	000_000	000_000	r,rw0,rw0,-,r,r,r							
1AH	PCLATH					PC[11]	PC[10]	PC[9]	PC[8]00000000	*****							
1BH	PCLATL	PC Low Byte for PC<7:0>											0000 0000	0000 0000	*****				
1DH	TBLPTRH					TBLPTR[11]	TBLPTR[10]	TBLPTR[9]	TBLPTR[8]00000000	*****							
1EH	TBLPTRL	Program Memory Table Pointer Low Byte (TBLPTR<7:0>)											0000 0000	0000 0000	*****				
1FH	TBLDH	Program Memory Table Latch High Byte											0000 0000	0000 0000	*****				
20H	TBLDL	Program Memory Table Latch Low Byte											0000 0000	0000 0000	*****				
21H	PRODH	Product Register of Multiply High Byte											xxxx xxxx	uuuu uuuu	r,r,r,r,r,r,r				
22H	PRODL	Product Register of Multiply Low Byte											xxxx xxxx	uuuu uuuu	r,r,r,r,r,r,r				
23H	INTE1	GIE	ADCIE	TMCIE				TMAIE	WDTIE	E1IE	E0IE	000_0000	000_0000	*****					
26H	INTF1		ADCIF	TMCIF				TMAIF	WDTIF	E1IF	E0IF	.00_0000	.00_0000	*****					
29H	WREG	Working Register											xxxx xxxx	uuuu uuuu	*****				
2AH	BSRCN												BSR[0]00	*****			
2BH	STATUS												C	DC	N	OVx xxxx	...u uuuu	*****
2CH	PSTATUS	PD	TO	IDLEB	BOR					SKERR	Z	000d_0_	uduu_d_	rw0,rw0,rw0,rw0,-,rw0,-					
2DH	LVDCN			LVDIF	LVD	LVDON						VLDX[3:0]	.000 0000	.000 uuuu	*****				
30H	PWRCN	ENVDDA	VDDAX[1:0]=11			ENACM						ENACM	0xx0	0xx0	*****				
31H	MCKCN1	ADCS[2:0]		ADCS[2:0]	ADCS[2:0]	ADCS[2:0]	XTSP	XTSP	ENXT	ENHAO	0000 0001		0000 0001	*****					
32H	MCKCN2			LSCK	HSCK	HSS[1:0]						CPUCK[1:0]	.00 0000	.00 0000	*****				
33H	MCKCN3	LDCS[2:0]					PERCK					BZS[2:0]	000_0000	000_0000	*****				
39H	ADCRH	ADC conversion memory HighByte											xxxx xxxx	uuuu uuuu	r,r,r,r,r,r,r				
3AH	ADCRM	ADC conversion memory Middle Byte											xxxx xxxx	uuuu uuuu	r,r,r,r,r,r,r				
3BH	ADCRL	ADC conversion memory Low Byte											0	0	0	0	xxxx 0000	uuuu 0000	r,r,r,r,r0,r0,r0,r0
3CH	ADCCN1	ENADC			ENCHP	PGAGN[1:0]					ADGN[2:0]	0.00 0000	0.00 0000	*****					
3DH	ADCCN2			INBUF=0	VRBUF=0	VREGN						DCSET[2:0]	.xx 0000	.xx 0000	*****				
3EH	ADCCN3	OSR[2:0]								OSR[3]	000_..0	000_..0	*****						
3FH	AINET1	INH[2:0]=XX0 or XX1(AI2 or AI0)				INL[2:0]=0XX or 1XX(AI1 or VSS)				INIS				xx00 xx0x	xx00 xx0x	*****			
40H	AINET2	VRH[1:0]=X0 or X1(AI2 or ACM)				INX[1:0]				VRL[1:0]=11(VSS)				xx00 xx0x	xx00 xx0x	*****			
41H	TMACN	ENTMA	TMACK	TMAS[1:0]		ENWDT		WDT[2:0]				0000 0000	0000 0000	***** w1,***					
42H	TMAR	TimerA data register											xxxx xxxx	uuuu uuuu	r,r,r,r,r,r,r				
46H	TMCCN	ENTMC	TMCC[1:0]		TMCS[1:2:0]			TMCS0[1:0]				0000 0000	0000 0000	*****					
47H	PRC	TimerC programmable register											1111 1111	1111 1111	*****				
48H	TMCR	TimerC register											0000 0000	0000 0000	r,r,r,r,r,r,r				
4FH	PWMCN	ENPWM	ENPFD	PWMRL[1:0]									0000	0000	*****				
51H	PWMR	PWM MSB Byte register											xxxx xxxx	uuuu uuuu	*****				
52H	LCDCN1	ENLCD	LCDPR		VLCDX[1:0]		LCDBF	LCDBI[1:0]=10				0000 0xxx	0000 0xxx	*****					
53H	LCDCN2	LCDBL	LCDMX[1:0]=11										0xxx xxxx	0xxx xxxx	*****				
54H	LCD0	Segment SEG2@[3:0] and SEG3@[7:4] data register of LCD											xxxx xxxx	uuuu uuuu	*****				
55H	LCD1	Segment SEG4@[3:0] and SEG5@[7:4] data register of LCD											xxxx xxxx	uuuu uuuu	*****				
56H	LCD2	Segment SEG6@[3:0] and SEG7@[7:4] data register of LCD											xxxx xxxx	uuuu uuuu	*****				
57H	LCD3	Segment SEG8@[3:0] and SEG9@[7:4] data register of LCD											xxxx xxxx	uuuu uuuu	*****				
58H	LCD4	Segment SEG10@[3:0] and SEG11@[7:4] data register of LCD											xxxx xxxx	uuuu uuuu	*****				
59H	LCD5	Segment SEG12@[3:0] and SEG13@[7:4] data register of LCD											xxxx xxxx	uuuu uuuu	*****				
5AH	LCD6	Segment SEG14@[3:0] and SEG15@[7:4] data register of LCD											xxxx xxxx	uuuu uuuu	*****				
5BH	LCD7	Segment SEG16@[3:0] and SEG17@[7:4] data register of LCD											xxxx xxxx	uuuu uuuu	*****				
5CH	LCD8	Segment SEG18@[3:0] and SEG19@[7:4] data register of LCD											xxxx xxxx	uuuu uuuu	*****				
5DH	LCD9	Segment SEG20@[3:0] and SEG21@[7:4] data register of LCD											xxxx xxxx	uuuu uuuu	*****				
6DH	PT1	PT1.7	PT1.6	PT1.5	PT1.4	PT1.3	PT1.2	PT1.1	PT1.0	xxxx xxxx	uuuu uuuu	***** r,r,r,r							
6EH	TRISC1	TC1.7	TC1.6	TC1.5	TC1.4					0000	0000	*****							
70H	PT1PU	PU1.7	PU1.6	PU1.5	PU1.4	PU1.3	PU1.2	PU1.1	PU1.0	0000 0000	0000 0000	*****							
71H	PT1M1					INTEG1[1:0]				INTEG0[1:0]			 0000 0000	*****			
72H	PT1M2	PM1_7[0]												.0_0_	*****			
74H	PT2					PT2.3	PT2.2	PT2.1	PT2.0 xxxx xxxx	*****							
75H	TRISC2					TC2.3	TC2.2	TC2.1	TC2.0 0000 0000	*****							
77H	PT2PU					PU2.3	PU2.2	PU2.1	PU2.0 0000 0000	*****							
78H	PT2M1			PM2.2[1]	PM2.2[0]							.0000	*****					
80H - FFH	GPR0	General Purpose Register as 128Byte											xxxx xxxx	uuuu uuuu	*****				
100H-17FH	GPR1	General Purpose Register as 128Byte											xxxx xxxx	uuuu uuuu	*****				

圖 5-1a HY11P36 暫存器列表

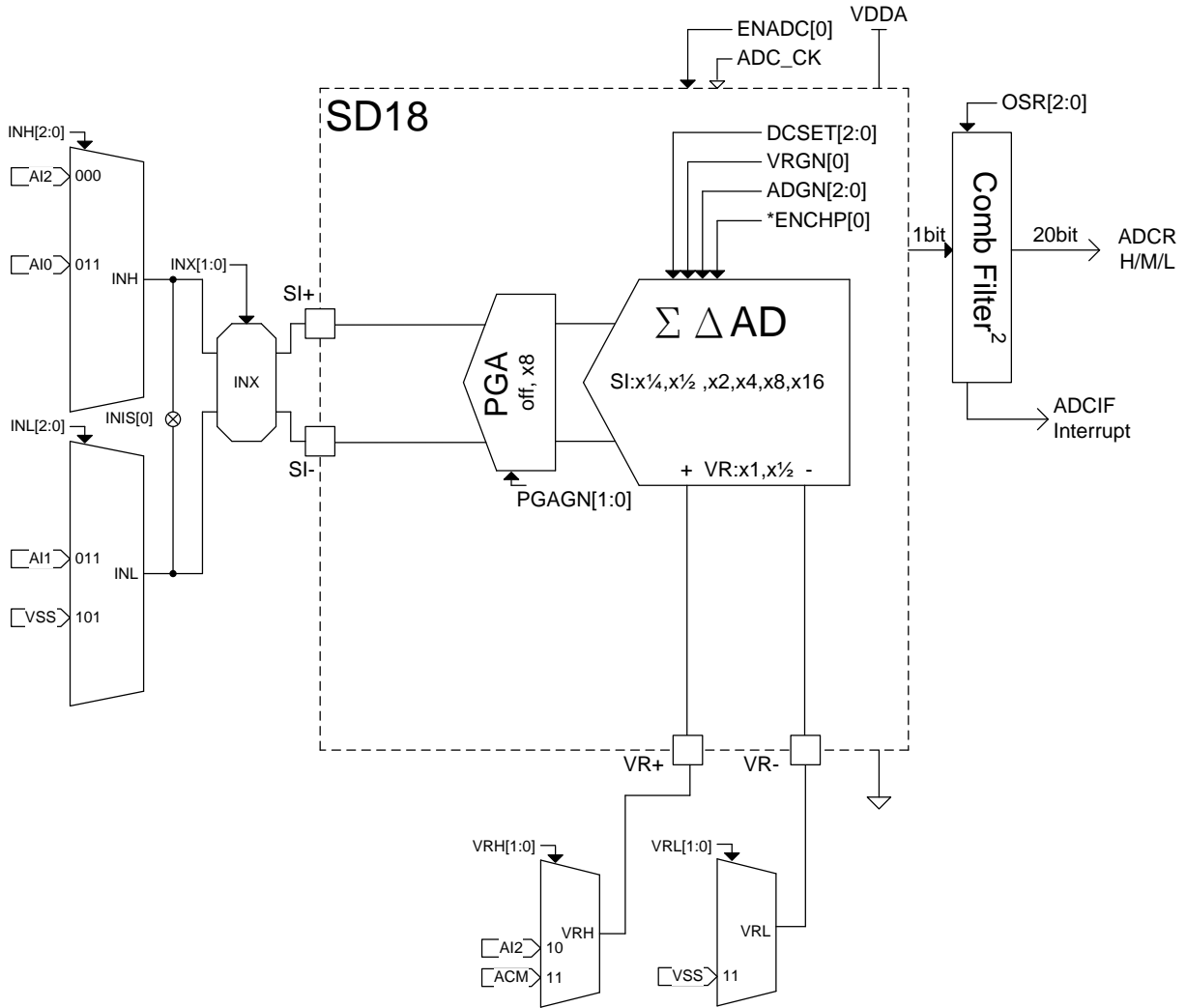
HY11P36

Embedded 18-Bit Σ ADC 8-Bit RISC-like Mixed Signal Microcontroller

"0" no use, "1" read/write, "w" write, "r" read, "r0" only read 0, "r1" only read 1, "w0" only write 0, "w1" only write 1													
"u" unimplemented bit, "x" unknown, "u" unchanged, "d" depends on condition													
Address	File Name	Bit7	Bit6	Bit5	Bit4	Bit3	Bit2	Bit1	Bit0	A-RESET	i-RESET	R/W	
180H	LCD10	Segment SEG22@[3:0] and SEG23@[7:4] data register of LCD								xxxx xxxx	uuuu uuuu	*****	
181H	LCD11	Segment SEG24@[3:0] and SEG25@[7:4] data register of LCD								xxxx xxxx	uuuu uuuu	*****	
182H	LCD12	Segment SEG26@[3:0] and SEG27@[7:4] data register of LCD								xxxx xxxx	uuuu uuuu	*****	
183H	LCD13	Segment SEG28@[3:0] and SEG29@[7:4] data register of LCD								xxxx xxxx	uuuu uuuu	*****	
184H	LCD14	Segment SEG30@[3:0] and SEG31@[7:4] data register of LCD								xxxx xxxx	uuuu uuuu	*****	
185H	LCD15	Segment SEG32@[3:0] and SEG33@[7:4] data register of LCD								xxxx xxxx	uuuu uuuu	*****	
195H	BICTRL					VPP_HIGH		BIEWR	BIERD	1000 d000	1000 d000	-,-,-,-,*,r0,*	
197H	BIEPTRL	0	0	BIE_ADDR[5:0]							0000 0000	0000 0000	w0,w0,*****
198H	BIEDH	BIE_DATA[15:8]								xxxx xxxx	xxxx xxxx	*****	
199H	BIEDL	BIE_DATA[7:0]								xxxx xxxx	xxxx xxxx	*****	

圖 5-1b HY11P36 暫存器列表

5.2 Internal RC Oscillator

$T_A = 25^\circ\text{C}, V_{DD} = 3.0\text{V}$, unless otherwise noted

Sym.	Parameter	Test Conditions	Min.	Typ.	Max.	unit
HAO	High Speed Oscillator frequency	ENHAO[0]=1	1.6	2.0	2.4	MHz
LPO	Low Power Oscillator frequency	V_{DD} supply voltage be enable LPO	22	28	35	KHz

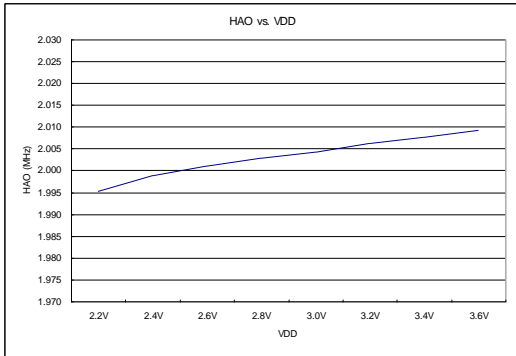

Figure 6.2-1 HAO vs. VDD

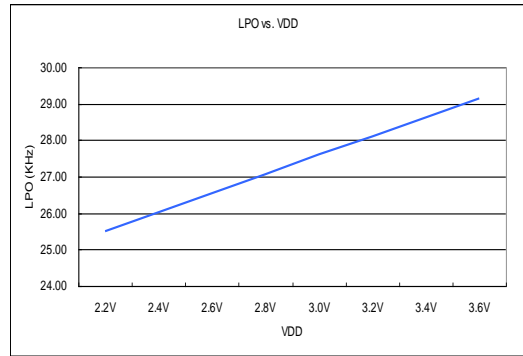

Figure 6.2-2 LPO vs. VDD

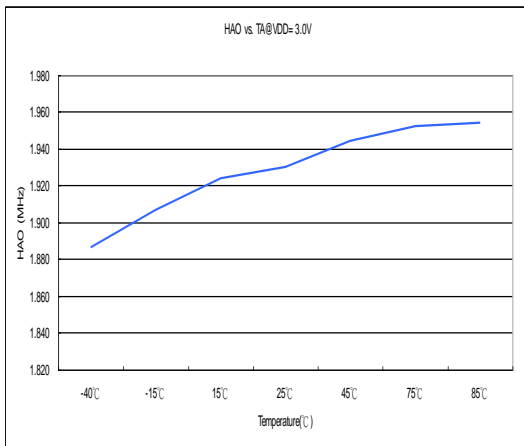

Figure 6.2-3 HAO vs. Temperature

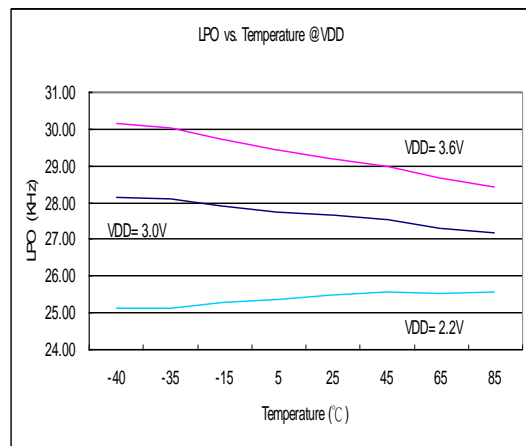

Figure 6.2-4 LPO vs. Temperature

5.3 Supply current into VDD excluding peripherals current

$T_A = 25^\circ\text{C}, V_{DD} = 3.0\text{V}, \text{OSC_LPO} = 28\text{KHz}$, unless otherwise noted

Sym.	Parameter	Test Conditions	Min.	Typ.	Max.	unit
I_{AM1}	Active mode 1	OSC_CY = 8MHz, OSC_HAO = off, CPU_CK = 8MHz		1.2	2	mA
I_{AM2}	Active mode 2	OSC_CY = off, OSC_HAO = 2MHz, CPU_CK = 2MHz		0.32	0.55	mA
I_{AM3}	Active mode 3	OSC_CY = off, OSC_HAO = 2MHz, CPU_CK = 1MHz		0.18	0.3	mA
I_{LP1}	Low Power 1	OSC_CY = 32768Hz, OSC_HAO = off, CPU_CK = 16384Hz		7	12	μA
I_{LP2}	Low Power 2	OSC_CY = off, OSC_HAO = off, CPU_CK = LPO, Idle state		1.65	3	μA
I_{LP3}	Low Power 3	OSC_CY = off, OSC_HAO = off, CPU_CK = off, Sleep state		0.65	1.2	μA

OSC_CY : External Oscillator frequency.

OSC_HAO : Internal High Accuracy Oscillator frequency.

CPU_CK : CPU core work frequency.

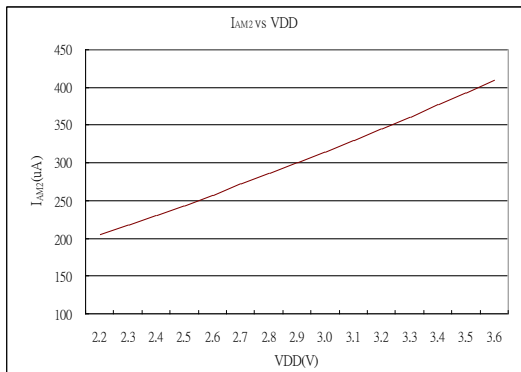

Figure 6.3-1 I_{AM2} vs. VDD

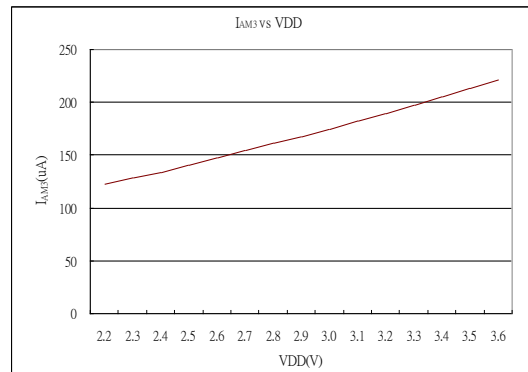

Figure 6.3-2 I_{AM3} vs. VDD

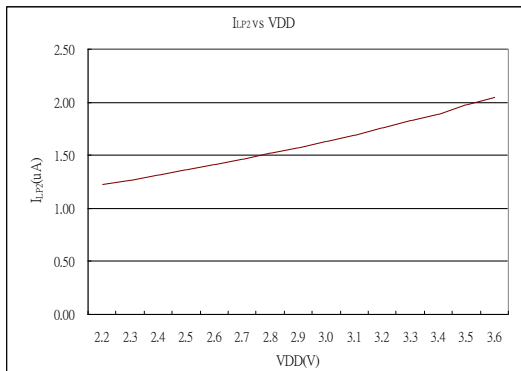

Figure 6.3-3 I_{LP2} vs. VDD

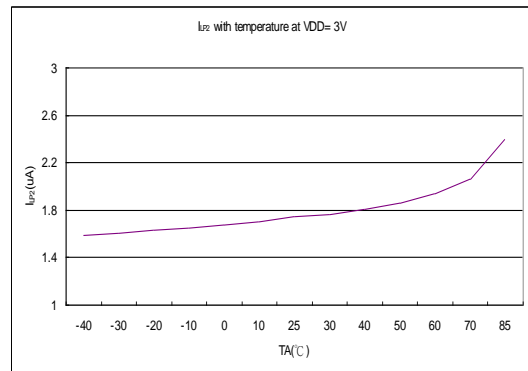

Figure 6.3-4 I_{LP2} vs. Temperature

Figure 6.3-5 I_{LP3} vs. VDD

HY11P36

Embedded 18-Bit $\Sigma\Delta$ ADC

8-Bit RISC-like Mixed Signal Microcontroller

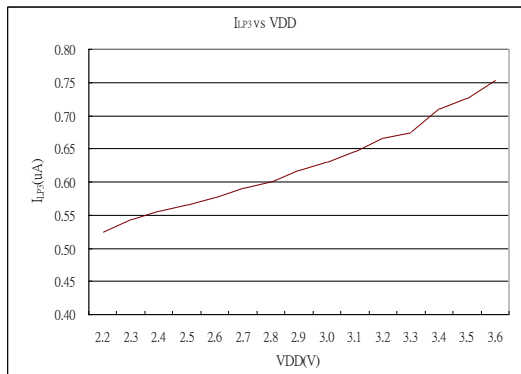

Figure 6.3-5 I_{LP3} vs. VDD

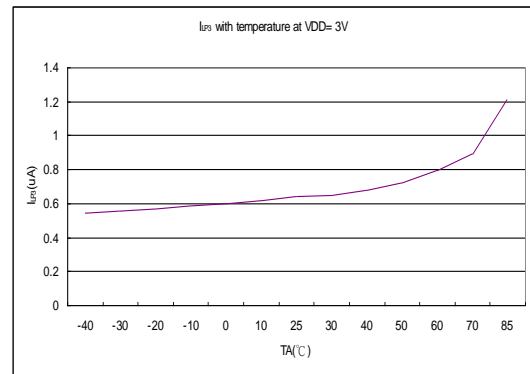

Figure 6.3-6 I_{LP3} vs. Temperature

5.4 Port1~2

$T_A = 25^\circ\text{C}, V_{DD} = 3.0\text{V}$, unless otherwise noted

Sym.	Parameter	Test Conditions	Min.	Typ.	Max.	unit
Input voltage and Schmitt trigger and leakage current and timing						
V_{IH}	High-Level input voltage				2.1	V
V_{IL}	Low-Level input voltage		0.9			
V_{hys}	Input Voltage hysteresis($V_{IH} - V_{IL}$)			0.8		V
I_{LKG}	Leakage Current				0.1	μA
R_{PU}	Port pull high resistance			180		$\text{k}\Omega$
Output voltage and current and frequency						
V_{OH}	High-level output voltage	$I_{OH}=10\text{mA}$	$V_{DD} - 0.3$			V
V_{OL}	Low-level output voltage	$I_{OL}=-10\text{mA}$	$V_{SS} + 0.3$			

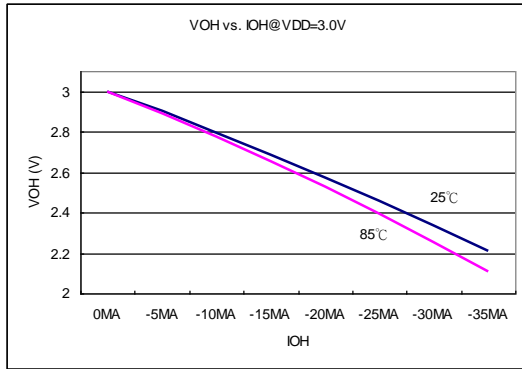

Figure 6.4-1 V_{OH} vs. I_{OH} @ $V_{DD}=3.0\text{V}$

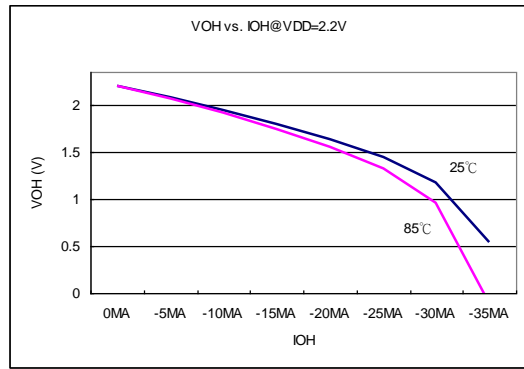

Figure 6.4-2 V_{OH} vs. I_{OH} @ $V_{DD}=2.2\text{V}$

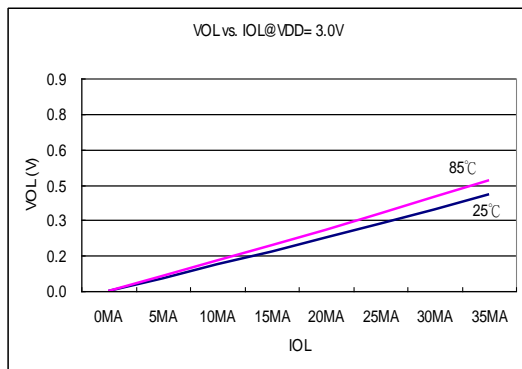

Figure 6.4-3 V_{OL} vs. I_{OL} @ $V_{DD}=3.0\text{V}$

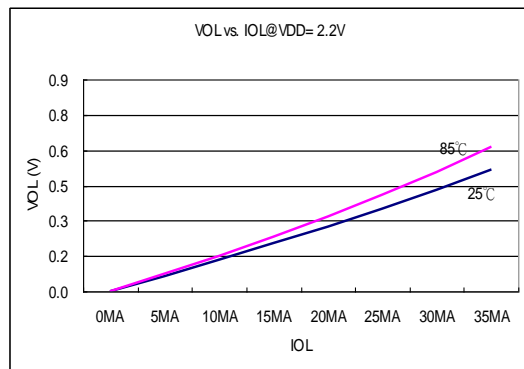

Figure 6.4-4 V_{OL} vs. I_{OL} @ $V_{DD}=2.2\text{V}$

5.5 Reset(Brownout, External RST pin, Low Voltage Detect)

$T_A = 25^\circ\text{C}, V_{DD} = 3.0\text{V}$, unless otherwise noted

Sym.	Parameter	Test Conditions	Min.	Typ.	Max.	unit	
BOR	Pulse length needed to accepted reset internally, t_{d-LVR}		2			us	
	V_{DD} Start Voltage to accepted reset internally (L \rightarrow H), V_{LVR}		1.6	1.85	2.1	V	
	Hysteresis, $V_{HYS-LVR}$			70		mV	
RST	Pulse length needed as RST/VPP pin to accepted reset internally, t_{d-RST}		2			us	
	Input Voltage to accepted reset internally		0.9			V	
	Hysteresis, $V_{HYS-RST}$			0.8		V	
LVD	Operation current, I_{LVD}			10	15	uA	
	External input voltage to compare reference voltage			1.2		V	
	Compare reference voltage temperature drift	$T_A = -40^\circ\text{C} \sim 85^\circ\text{C}$		100		ppm/ $^\circ\text{C}$	
	Detect V_{DD} voltage rang by user option, $V_{SVS} VLDx[3:0]=1110b$			3.3		V	
	Detect V_{DD} voltage rang by user option, $V_{SVS} VLDx[3:0]=1101b$			3.2			
	Detect V_{DD} voltage rang by user option, $V_{SVS} VLDx[3:0]=1100b$			3.1			
	Detect V_{DD} voltage rang by user option, $V_{SVS} VLDx[3:0]=1011b$			3.0			
	Detect V_{DD} voltage rang by user option, $V_{SVS} VLDx[3:0]=1010b$			2.9			
	Detect V_{DD} voltage rang by user option, $V_{SVS} VLDx[3:0]=1001b$			2.8			
	Detect V_{DD} voltage rang by user option, $V_{SVS} VLDx[3:0]=1000b$			2.7			
	Detect V_{DD} voltage rang by user option, $V_{SVS} VLDx[3:0]=0111b$			2.6			
	Detect V_{DD} voltage rang by user option, $V_{SVS} VLDx[3:0]=0110b$			2.5			
	Detect V_{DD} voltage rang by user option, $V_{SVS} VLDx[3:0]=0101b$			2.4			
	Detect V_{DD} voltage rang by user option, $V_{SVS} VLDx[3:0]=0100b$			2.3			
	Detect V_{DD} voltage rang by user option, $V_{SVS} VLDx[3:0]=0011b$			2.2			
	Detect V_{DD} voltage rang by user option, $V_{SVS} VLDx[3:0]=0010b$			2.1			
	Detect V_{DD} voltage rang by user option, $V_{SVS} VLDx[3:0]=0001b$			2.0			
BOR : Brownout Reset LVR : Low Voltage Reset of BOR LVD : Low Voltage Detect RST : External Reset pin							

HY11P36

Embedded 18-Bit Σ ADC
8-Bit RISC-like Mixed Signal Microcontroller

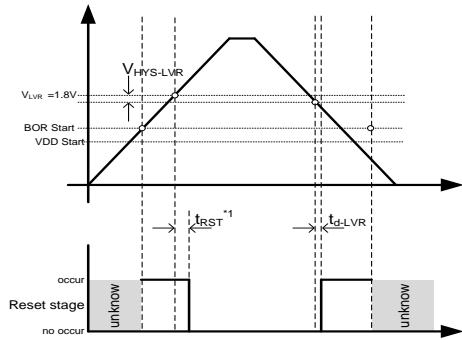

Figure 6.5-1 BOR reset diagram

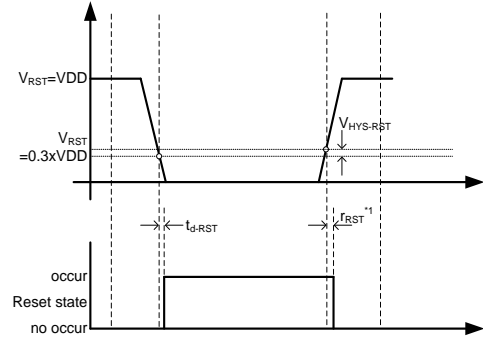

Figure 6.5-2 RST reset diagram

*1 t_{RST} : Please see BOR Introduce of HY11Pxx series User's Guide (UG-HY11S14-Vxx).

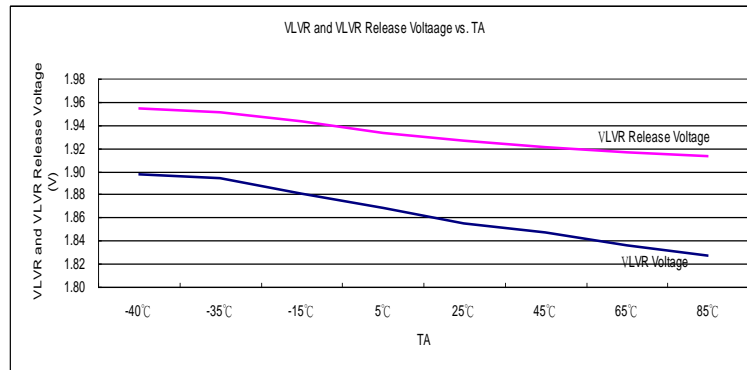

Figure 6.5-3 LVR vs. Temperature

5.6 Power System

$T_A = 25^\circ\text{C}, V_{DD} = 3.0\text{V}$, unless otherwise noted

Sym.	Parameter	Test Conditions		Min.	Typ.	Max.	unit
VDDA	VDDA operation current, I_{VDDA}	$I_L = 0\text{mA}$	VDDAX[1:0]=00b	22			μA
	Select VDDA output voltage	$I_L = 0.1\text{mA}$, $V_{DD} \geq V_{VDDA} + 0.25\text{V}$	VDDAX [1:0]=11b	2.4			V
	Dropout voltage	$I_L = 10\text{mA}$	VDDAX [1:0]=11b	250			mV
	Temperature drift	VDDAX [1:0]=11b	$T_A = -40^\circ\text{C} \sim 85^\circ\text{C}$	50			ppm/ $^\circ\text{C}$
	V_{DD} Voltage drift	$I_L = 0.1\text{mA}$	$V_{DD} = 2.5\text{V} \sim 3.6\text{V}$	± 0.2			%/V
ACM	ACM operation current, I_{ACM}	$I_L = 0\text{mA}$		20			μA
	Output voltage, V_{ACM}	ENACM[0]=1	$I_L = 0\mu\text{A}$	1.0			V
	Output voltage with Load		$I_L = \pm 200\mu\text{A}$	0.98	1.02		V_{ACM}
	Temperature drift	ENACM[0]=1,	$T_A = -40^\circ\text{C} \sim 85^\circ\text{C}$	50			ppm/ $^\circ\text{C}$
	VDDA Voltage drift	$I_L = 10\mu\text{A}$		100			$\mu\text{V}/\text{V}$

VDDA : Adjust Voltage Regulator
ACM : Analog Common Mode Voltage

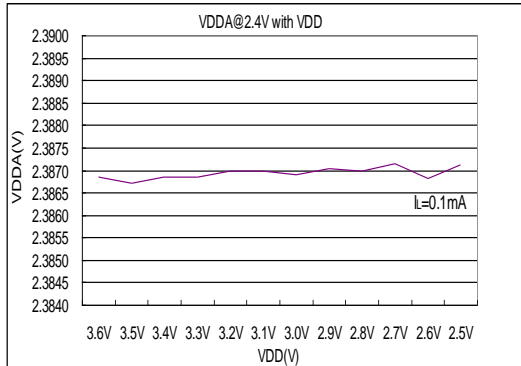

Figure 6.6-1 VDDA $I_L = 0.1\text{mA}$ vs. VDD

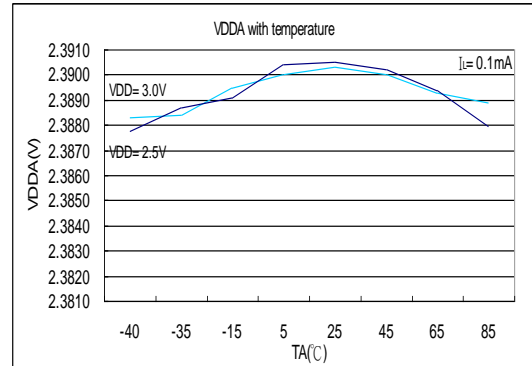

Figure 6.6-2 VDDA $I_L = 0.1\text{mA}$ vs. Temperature

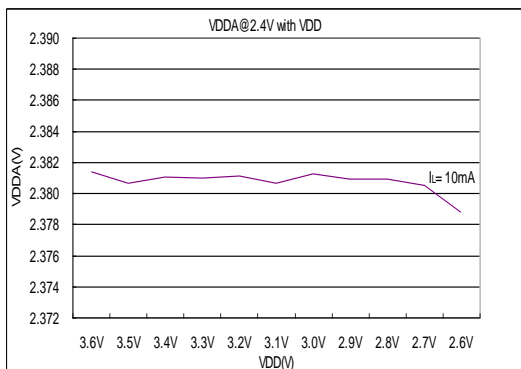

Figure 6.6-3 VDDA $I_L = 10\text{mA}$ vs. VDD

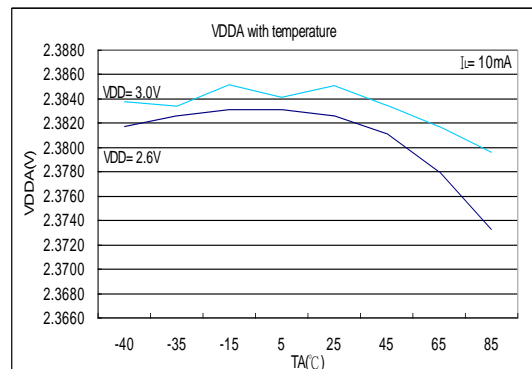

Figure 6.6-4 VDDA $I_L = 10\text{mA}$ vs. Temperature

HY11P36

Embedded 18-Bit $\Sigma\Delta$ ADC

8-Bit RISC-like Mixed Signal Microcontroller

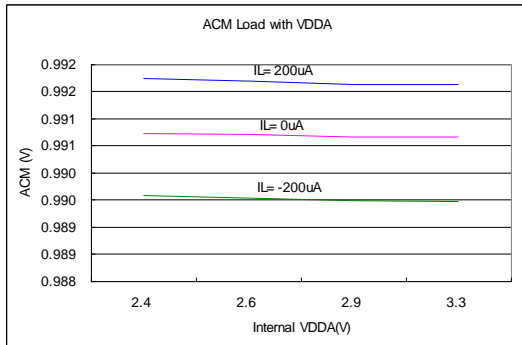

Figure6.6-5 ACM Load vs. VDDA

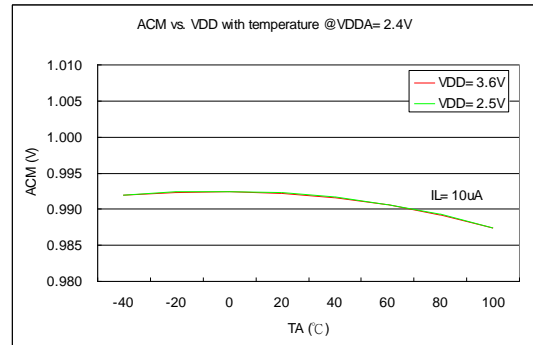

Figure6.6-6 ACM vs. Temperature

5.7 LCD

$T_A = 25^\circ\text{C}, V_{DD} = 3.0\text{V}, C_{VLCD} = 4.7\mu\text{F}$, unless otherwise noted.

Sym.	Parameter	Test Conditions	Min.	Typ.	Max.	unit	
I_{LCD}	Operation supply current without output buffer.(all segment turn on)	LCDPR[0]=1	$V_{DD} = 2.2\text{V}$	10		uA	
			$V_{DD} = 3.0\text{V}$				
VLCD	Supply Voltage at VLCD pin	LCDPR[0]=0	2.2		3.6	V	
	Embedded Charge Pump output voltage at VLCD pin	$V_{DD} = 2.2\text{V}$, LCDPR[0]=1, $C_{VLCD} = 4.7\mu\text{F}$	VLCDX[1:0]=11b	2.295	2.55	2.805	V
			VLCDX[1:0]=10b	2.52	2.8	3.08	
			VLCDX[1:0]=01b	2.745	3.05	3.355	
VLCDX[1:0]=00b	2.97	3.3	3.63				
Z_{LCD}	Output impedance with LCD buffer	$f_{LCD} = 128\text{Hz}, VLCD = 3.05\text{V}$		10		k Ω	

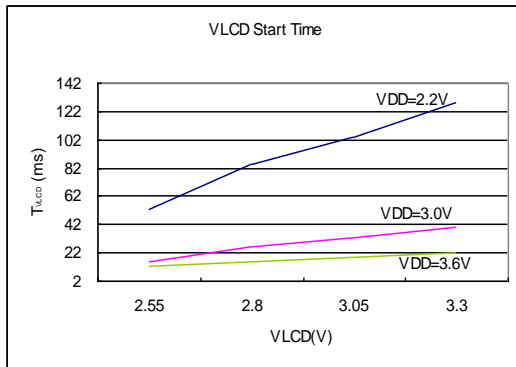

Figure6.7-1 LCD start time

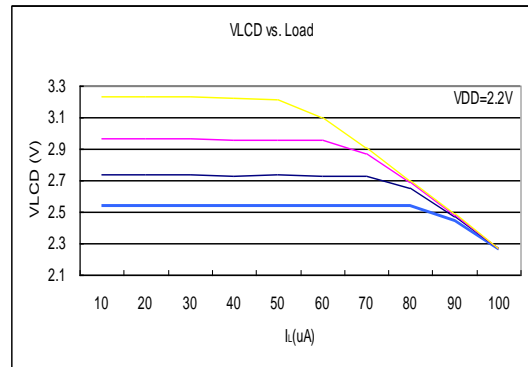

Figure6.7-2 VLCD vs. I_L @ VDD=2.2V

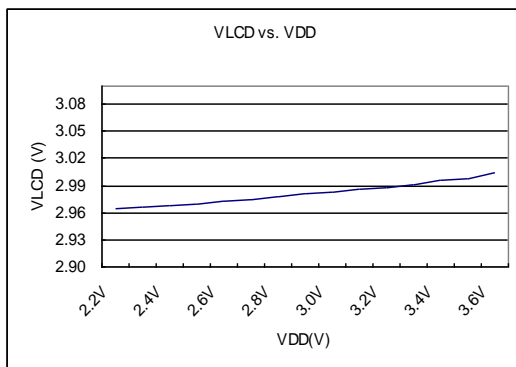

Figure6.7-3 VLCD vs. VDD

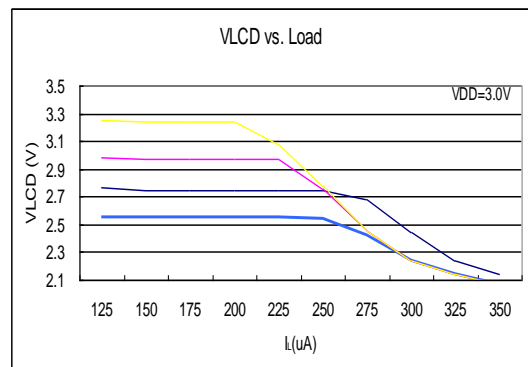

Figure6.7-4 VLCD vs. I_L @ VDD=3.0V

5.8 SD18, Power Supply and recommended operating conditions

$T_A = 25^\circ\text{C}, V_{DD} = 3.0\text{V}, V_{DDA}=2.4\text{V}$, unless otherwise noted

Sym.	Parameter	Test Conditions		Min.	Typ.	Max.	unit
V_{SD18}	Supply Voltage at VDDA	ENVDDA[0]=0		2.4		3.6	V
f_{SD18}	Modulator sample frequency, ADC_CK			25	250	300	KHz
	Over Sample Ratio, OSR			128 ^{*1}		32768	
I_{SD18}	Operation supply current without PGA	ENADC[0]=1 INBUF[0]=0, VRBUF[0]=0	GAIN =4, ADC_CK=250KHz		120		μA

*1, OSR=128, setting by ADCCN3[OSR3] bit.
OSR[3:0]=1010b, OSR=128; OSR[3:0]=0xxx, OSR=256 ~ 32768
OSR[3:0]=1xxx b can't set by user

5.8.1 PGA, Power Supply and recommended operating conditions

$T_A = 25^\circ\text{C}, V_{DD} = 3.0\text{V}, V_{DDA}=2.4\text{V}$, unless otherwise noted

Sym.	Parameter	Test Conditions		Min.	Typ.	Max.	unit
V_{PGA}	Supply Voltage at VDDA	ENVDDA[0]=0		2.4		3.6	V
I_{PGA}	Operation supply current	PGAGN[1:0]=<11>			320		μA
G_{PGA}	Gain temperature drift	$T_A = -40^\circ\text{C} \sim 85^\circ\text{C}$	GAIN=128		15		ppm/ $^\circ\text{C}$

5.8.2 SD18, performance II ($f_{SD18}=250\text{KHz}$)

$T_A = 25^\circ\text{C}, V_{DD} = 3.0\text{V}, V_{DDA}=2.9\text{V}, V_{VR}=1.0\text{V}, \text{GAIN}=1$ without PGA, unless otherwise noted

Sym.	Parameter	Test Conditions		Min.	Typ.	Max.	unit
INL	Integral Nonlinearity(INL)	$V_{DDA}=2.4\text{V}, V_{VR}=1.0\text{V}, \Delta\text{SI}=\pm 200\text{mV}$			± 0.003	± 0.01	%FSR
		$V_{DDA}=2.4\text{V}, V_{VR}=1.0\text{V}, \Delta\text{SI}=\pm 450\text{mV}$					
	No Missing Codes ³	ADC_CK=250KHz, OSR[2:0]=010b		19			Bits
G_{SD18}	Temperature drift Gain 1~x16 (INBUF[0]=0b,)	INBUF[0]=0b, VRBUF[0]=0b	$T_A = -40^\circ\text{C} \sim 85^\circ\text{C}$		10		ppm/ $^\circ\text{C}$
Eos	Offset error of Full Scale Rang input voltage range with Chopper without PGA	$\Delta\text{AI}=0\text{V}$ $\Delta\text{VR}=0.9\text{V}$	Gain=2			1	%FSR
			GAIN=1		2		$\mu\text{V}/^\circ\text{C}$
	GAIN=2		1				
	GAIN=4		0.5				
	Offset error temperature drift with chopper without PGA		$\text{DCSET}[2:0]=\langle 000 \rangle$ * ΔAI is external short	GAIN=16		0.15	

$T_A = 25^\circ\text{C}, V_{DD} = 3.0\text{V}, V_{DDA}=2.9\text{V}, V_{VR}=1.0\text{V}, \text{GAIN}=1$ without PGA, unless otherwise noted

Sym.	Parameter	Test Conditions		Min.	Typ.	Max.	unit
CM _{SD18}	Common-mode rejection	$V_{CM}=0.7\text{V}$ to 1.7V , $V_{VR}=1.0\text{V}$, without PGA	$V_{SI}=0\text{V}$, GAIN=1		90		dB
		$V_{CM}=0.7\text{V}$ to 1.7V , $V_{VR}=1.0\text{V}$, without PGA	$V_{SI}=0\text{V}$, GAIN=16		75		
PSRR	DC power supply rejection	$V_{DDA}=3.0\text{V}, \Delta V_{DDA}=\pm 100\text{mV}$, $V_{VR}=1.0\text{V}, V_{SI}=1.2\text{V}, V_{SI}=1.2\text{V}$,	GAIN=1 PGA=off		75		dB
			GAIN=16 PGA=8				

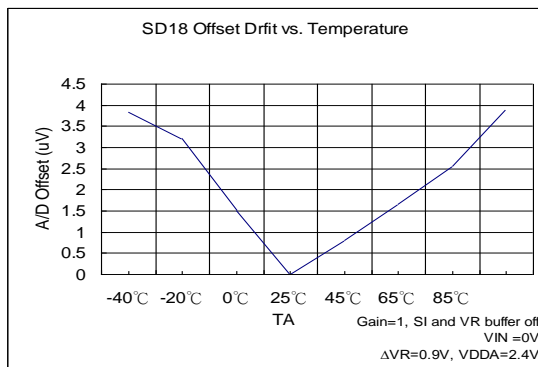

Figure 6.8-1(a) SD18 Offset Temperature drift

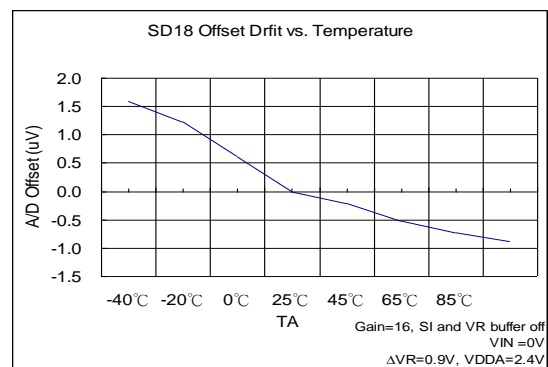

Figure 6.8-1(b) SD18 Offset Temperature drift

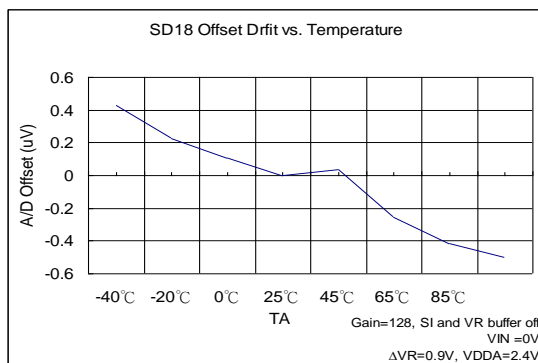

Figure 6.8-1(c) SD18 Offset Temperature drift

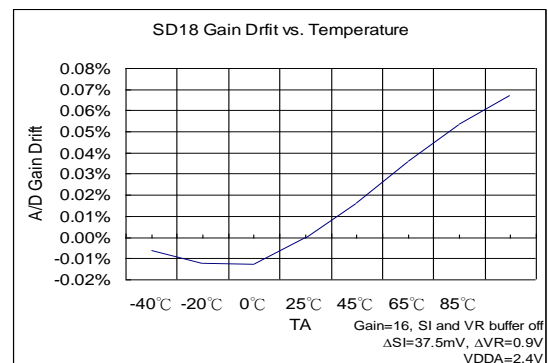

Figure 6.8-2(a) SD18 Gain drift with temperature

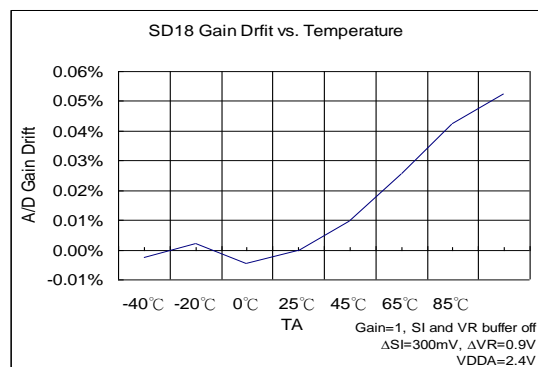

Figure 6.8-2(b) SD18 Gain drift with temperature

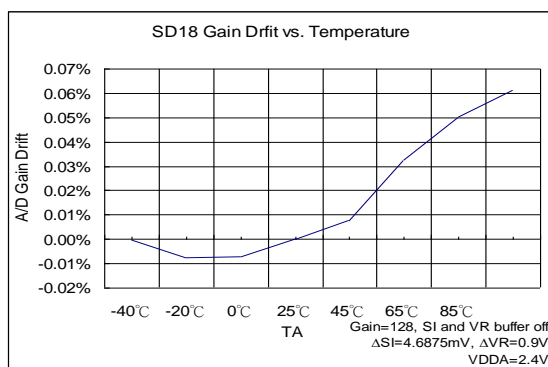

Figure 6.8-2(c) SD18 Gain drift with temperature

5.8.3 SD18 Noise Performance

$T_A = 25^\circ\text{C}, V_{DD} = 3.0\text{V}, V_{DDA} = 2.4\text{V}$, unless otherwise noted

HY11P36 針對 SD18 提供了重要的輸入雜訊規格。Table6.8-3(a), Table6.8-3(b) 列出典型的雜訊規格表與 Gain, Output rate, 及單端最大輸入電壓等關係。測試條件設定在外部輸入訊號短路，參考電壓為 1.2V，取樣 1024 筆資料。

ENOB(RMS) with OSR/GAIN at A/D Clock=250Khz, VDDA=2.4V, VREF=1.2V														
Max. Vin(mV) =0.9*VREF ⁽¹⁾	OSR				128	256	512	1024	2048	4096	8192	16384	32768	
	Output rate(HZ)				1953	977	488	244	122	61	31	15	8	
	Gain	=	PGA	x										ADGN
±2400	0.25	=	1	x	0.25	14.43	16.07	17.20	17.86	18.29	18.66	18.98	19.13	19.30
±2160	0.5	=	1	x	0.5	14.34	16.05	17.13	17.84	18.26	18.62	18.90	19.13	19.27
±1080	1	=	1	x	1	14.38	16.06	17.11	17.72	18.13	18.53	18.88	19.05	19.22
±540	2	=	1	x	2	14.40	15.98	16.96	17.59	18.01	18.45	18.79	19.01	19.17
±270	4	=	1	x	4	14.39	15.88	16.82	17.39	17.85	18.28	18.65	18.95	19.13
±135	8	=	1	x	8	14.27	15.75	16.58	17.15	17.60	18.04	18.45	18.78	19.02
±68	16	=	1	x	16	14.14	15.51	16.18	16.73	17.21	17.70	18.15	18.52	18.83
±8	128	=	8	x	16	13.04	13.83	14.32	14.87	15.38	15.86	16.36	16.84	17.28

(1) Max.Vin (mV) is the max. input voltage of single end to ground (VSS).

Table6.8-3(a) SD18 ENOB Table

RMS Noise(uV) with OSR/GAIN at A/D Clock=250Khz, VDDA=2.4V, VREF=1.2V														
Max. Vin(mV) =0.9*VREF	OSR				128	256	512	1024	2048	4096	8192	16384	32768	
	Output rate(HZ)				1953	977	488	244	122	61	31	15	8	
	Gain	=	PGA	x										ADGN
±2400	0.25	=	1	x	0.25	362.92	139.77	64.33	40.65	30.04	23.35	18.70	16.75	14.92
±2160	0.5	=	1	x	0.5	193.22	70.82	33.83	20.60	15.37	12.00	9.86	8.38	7.61
±1080	1	=	1	x	1	94.14	35.38	17.16	11.17	8.40	6.34	5.01	4.44	3.92
±540	2	=	1	x	2	46.23	18.59	9.48	6.13	4.57	3.35	2.66	2.28	2.05
±270	4	=	1	x	4	23.37	9.98	5.20	3.51	2.54	1.89	1.46	1.18	1.05
±135	8	=	1	x	8	12.66	5.47	3.06	2.06	1.51	1.11	0.84	0.67	0.56
±68	16	=	1	x	16	6.93	3.23	2.02	1.38	0.99	0.70	0.51	0.40	0.32
±8	128	=	8	x	16	1.86	1.29	0.91	0.63	0.44	0.32	0.22	0.16	0.12

Table6.8-3(b) SD18 RMS Noise Table

The RMS noise are referred to the input. The Effective Number of Bits (ENOB(RMS Bit)) is defined as:

$$\text{ENOB(RMS)} = \frac{\ln\left(\frac{\text{FSR}}{\text{RMS Noise}}\right)}{\ln(2)}$$

$$\text{RMS Noise} = \frac{\left(2 \times \text{VREF} \times \sqrt{\sum_{k=1}^{1024} (\text{ADO}[k] - \text{Average})^2}\right)}{2^{23}}$$

Where FSR (Full- Scale Range) = $2 \times \text{VREF} / \text{Gain}$.

$$\text{Average} = \frac{\sum_{k=1}^{1024} (\text{ADO}[k])}{1024}$$

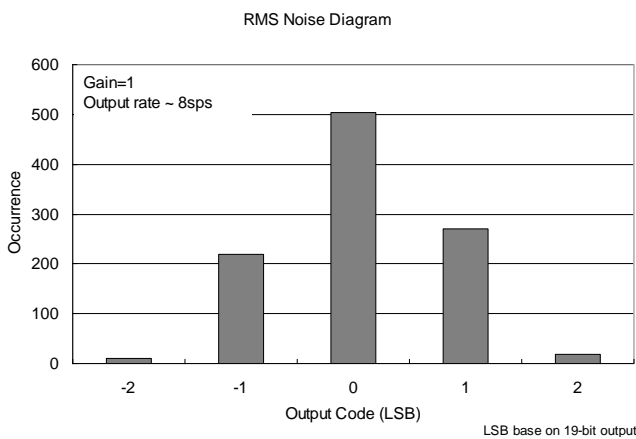

Figure6.8-3(a) RMS Noise Diagram

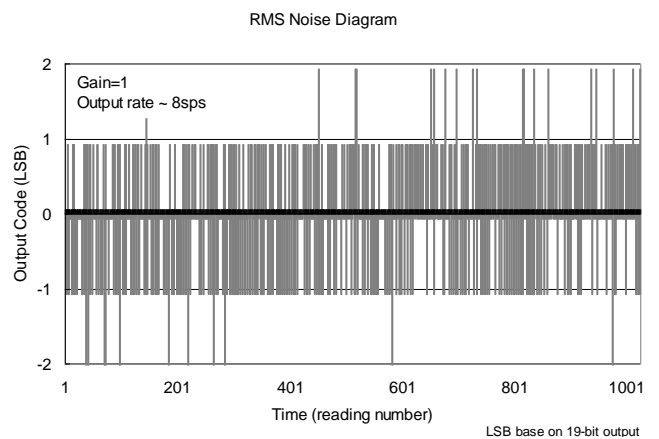

Figure6.8-3(b) Output Code Diagram

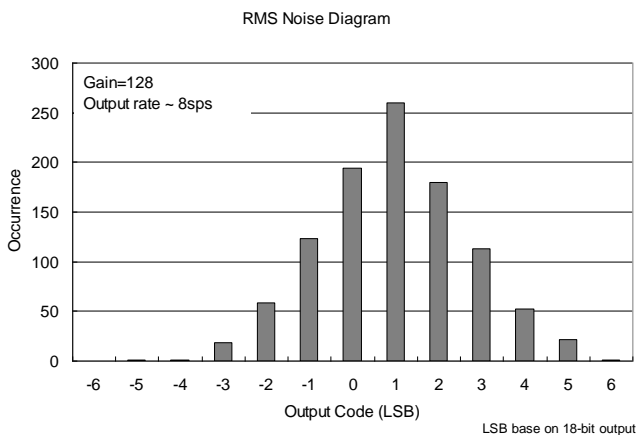

Figure6.8-3(c) RMS Noise Diagram

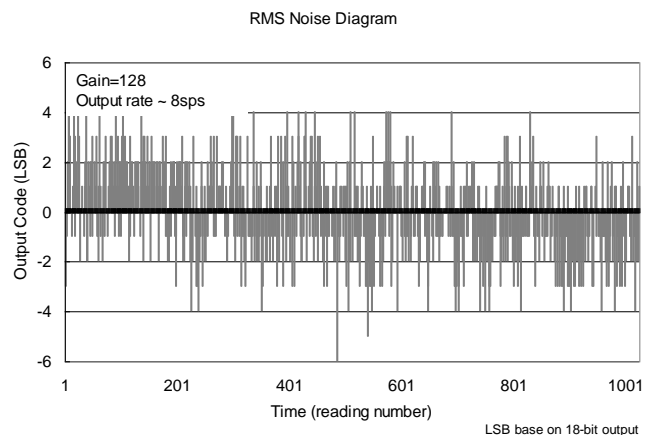

Figure6.8-3(d) Output Code Diagram

5.9 Build-In EPROM(BIE)

$T_A = 25^\circ\text{C}, V_{DD} = 3.0\text{V}$, unless otherwise noted

Sym.	Parameter	Test Conditions	Min.	Typ.	Max.	unit
V_{BIE}	Supply Voltage			6.0	6.5	V
I_{BIE}	Operation supply current			5		mA
V_{SS}	Supply Voltage			0		V

6. 訂貨資訊

下單品名 ¹	封裝型式	引腳數	封裝型式 描述方式		程式碼 編號 ²	出貨包裝 形式	個裝 數量	材料 組成	MSL ³
			D	000					
HY11P36-D000	Die	-	D	000	000	-	200	Green ⁴	-
HY11P36-L064	LQFP	64	L	064	000	Tray	250	Green ⁴	MSL-3

¹ 產品名稱 – 封裝型式描述方式 – 程式碼編號 (空白片 / 標準品 / 代客燒錄碼)

例如：您的需求是不帶程式碼的空白片且需要的產品是裸片出貨，晶片型號為 HY11P36。則下單品名為 HY11P36-D000

例如：您的代客燒錄服務申請的程式碼編號為 008，晶片型號為 HY11P36，且需要的產品是裸片出貨。則下單品名為 HY11P36-D000-008

例如：您的需求是晶片型號為 HY11P36，不帶程式碼的空白片且需要的產品是封裝片 LQFP64 出貨，則下單品名為 HY11P36-L064，且需以 Tray 出貨，則除下單品名外，請特別註明出貨包裝形式為 Tray

例如：您的需求是晶片型號為 HY11P36，代客燒錄服務申請的程式碼編號為 009，而需求的產品是封裝片 LQFP64 出貨，則下單品名為 HY11P36-L064-009，且需以 Tray 出貨，則除下單品名外，請特別註明出貨包裝形式為 Tray

² 程式碼編號

“001”~“999” 為標準品或代客燒錄申請的程式碼編號，而空白晶片不帶此碼。

³ MSL:

濕度敏感性等級係依據 IPC/JEDEC J-STD-020 的規範加以試驗分級，並參考 IPC/JEDEC J-STD-033 的標準處理、包裝、運輸與使用。

⁴ Green (RoHS & no Cl/Br):

HYCON 產品皆為 Green Product，符合 RoHS 指令以及無鹵素規定(Br/Cl<0.1%)

HY11P36

Embedded 18-Bit $\Sigma\Delta$ ADC
8-Bit RISC-like Mixed Signal Microcontroller

7. 封裝型式資訊

7.1 LQFP64(L064)

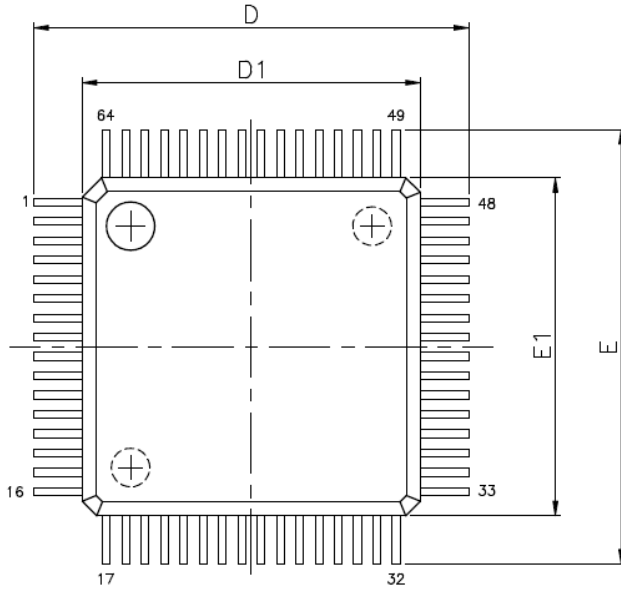

VARIATIONS (ALL DIMENSIONS SHOWN IN MM)

SYMBOLS	MIN.	NOM.	MAX.
A	—	—	1.60
A1	0.05	—	0.15
A2	1.35	1.40	1.45
b	0.13	0.18	0.23
c	0.09	—	0.20
D	9.00 BSC		
D1	7.00 BSC		
e	0.40 BSC		
E	9.00 BSC		
E1	7.00 BSC		
L	0.45	0.60	0.75
L1	1.00 REF		
θ	0°	3.5°	7°

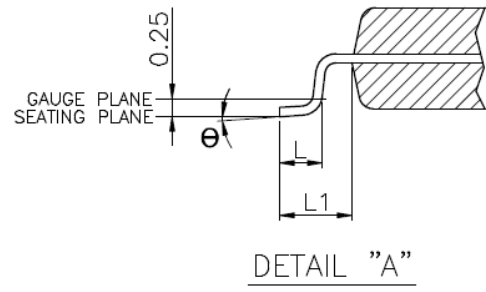
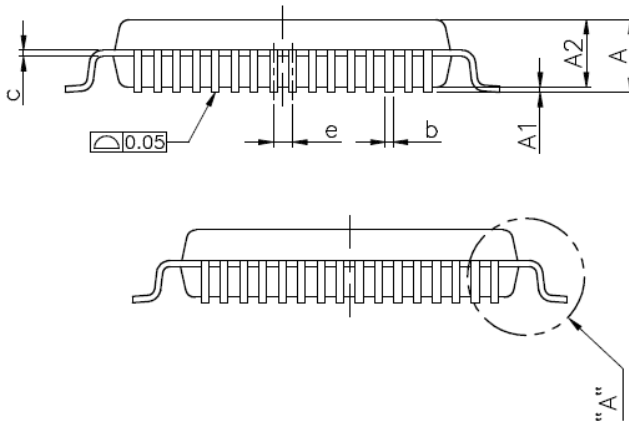

JEDEC MS-026 compliant

8. 修訂記錄

以下描述本文件差異較大的地方，而標點符號與字形的改變不在此描述範圍。

版本	頁次	變更摘要
V02	ALL	初版發行
V03	4	修正產品特點-刪除內建低壓燒錄控制電路特性
V04	11	修正 SD18 Network