



HY16F19 系列

HYCON IP 使用說明書

Table of Contents

1.	文件說明	7
2.	晶片說明	7
3.	數位 IP(TIMER).....	9
3.1.	範例名稱.....	9
3.2.	範例說明.....	9
3.3.	軟體流程.....	9
3.4.	程式碼	10
4.	數位 IP(WDT)	19
4.1.	範例名稱.....	19
4.2.	範例說明.....	19
4.3.	軟體流程.....	19
4.4.	程式碼	20
5.	數位 IP(WDT RESET).....	26
5.1.	範例名稱.....	26
5.2.	範例說明.....	26
5.3.	軟體流程.....	26
5.4.	程式碼	27
6.	數位 IP(RTC).....	34
6.1.	範例名稱.....	34
6.2.	範例說明.....	34
6.3.	軟體流程.....	34

6.4.	程式碼	35
7.	數位 IP(PWM).....	43
7.1.	範例名稱.....	43
7.2.	範例說明.....	43
7.3.	軟體流程.....	43
7.4.	程式碼	44
8.	數位 IP(FLASH)	49
8.1.	範例名稱.....	49
8.2.	範例說明.....	49
8.3.	程式碼	49
9.	數位 IP(GPIO).....	56
9.1.	範例名稱.....	56
9.2.	範例說明.....	56
9.3.	軟體流程.....	56
9.4.	程式碼	57
10.	類比 IP(8 BIT RESISTANCE LADDER DAC).....	64
10.1.	範例名稱.....	64
10.2.	範例說明.....	64
10.3.	軟體流程.....	64
10.4.	程式碼	65
11.	類比 IP(OPA)	70
11.1.	範例名稱.....	70
11.2.	範例說明.....	70

11.3.	軟體流程.....	70
11.4.	程式碼	71
12.	類比 IP(ADC).....	78
12.1.	範例名稱.....	78
12.2.	範例說明.....	78
12.3.	軟體流程.....	78
12.4.	程式碼	79
13.	類比 IP(LCD)	87
13.1.	範例名稱.....	87
13.2.	範例說明.....	87
13.3.	軟體流程.....	87
13.4.	程式碼	88
14.	類比 IP(CMP).....	94
14.1.	範例名稱.....	94
14.2.	範例說明.....	94
14.3.	程式碼	94
15.	通訊 IP(SPI)	102
15.1.	範例名稱.....	102
15.2.	範例說明.....	102
15.3.	系統設定.....	102
15.4.	軟體流程.....	103
15.5.	程式碼	104
16.	通訊 IP(UART).....	112

16.1.	範例名稱.....	112
16.2.	範例說明.....	112
16.3.	軟體流程.....	112
16.4.	程式碼	113
17.	通訊 IP(UART2)	125
17.1.	範例名稱.....	125
17.2.	範例說明.....	125
17.3.	軟體流程.....	125
17.4.	程式碼	126
18.	通訊 IP(I2C)	138
18.1.	範例名稱.....	138
18.2.	範例說明.....	138
18.3.	系統設定.....	138
18.4.	軟體流程.....	139
18.5.	程式碼	139
19.	其他 IP(Power)	149
19.1.	範例名稱.....	149
19.2.	範例說明.....	149
19.3.	軟體流程.....	149
19.4.	程式碼	150
20.	修訂記錄	156

注意：

- 1、本說明書中的內容，隨著產品的改進，有可能不經過預告而更改。請客戶及時到本公司網站下載更新 <http://www.hycontek.com>。
- 2、本規格書中的圖形、應用電路等，因第三方工業所有權引發的問題，本公司不承擔其責任。
- 3、本產品在單獨應用的情況下，本公司保證它的性能、典型應用和功能符合說明書中的條件。當使用在客戶的產品或設備中，以上條件我們不作保證，建議客戶做充分的評估和測試。
- 4、請注意輸入電壓、輸出電壓、負載電流的使用條件，使 IC 內的功耗不超過封裝的容許功耗。對於客戶在超出說明書中規定額定值使用產品，即使是瞬間的使用，由此所造成的損失，本公司不承擔任何責任。
- 5、本產品雖內置防靜電保護電路，但請不要施加超過保護電路性能的過大靜電。
- 6、本規格書中的產品，未經書面許可，不可使用在要求高可靠性的電路中。例如健康醫療器械、防災器械、車輛器械、車載器械及航空器械等對人體產生影響的器械或裝置，不得作為其部件使用。
- 7、本公司一直致力於提高產品的品質和可靠度，但所有的半導體產品都有一定的失效概率，這些失效概率可能會導致一些人身事故、火災事故等。當設計產品時，請充分留意冗餘設計並採用安全指標，這樣可以避免事故的發生。
- 8、本規格書中內容，未經本公司許可，嚴禁用於其他目的之轉載或複製。

1. 文件說明

HYCON IP(IP 矽智財 Intellectual Property 縮寫)，代表紘康 32 位元 MCU 內部各元件的(矽智財)半導體矽晶片智慧財產權。本文件針對 HY16F19 系列，SOC 晶片內數位、類比及通訊等其它周邊 IP 做使用說明。

主要包含以下 4 大分類:

- (1)數位 IP：TimerA/TimerB/timerB2/TimerC/WDT/PWM/Hardware RTC/GPIO
- (2)類比 IP：8 bit Resistance Ladder(DAC)/ADC/OPAMP/LCD/CMP
- (3)通訊 IP：Hardware 32-bit SPI/ Hardware UART/ Hardware UART 2/ Hardware I2C
- (4)其他 IP：Power Management

2. 晶片說明

HY16F19xB 各功能 IP 基礎使用說明。

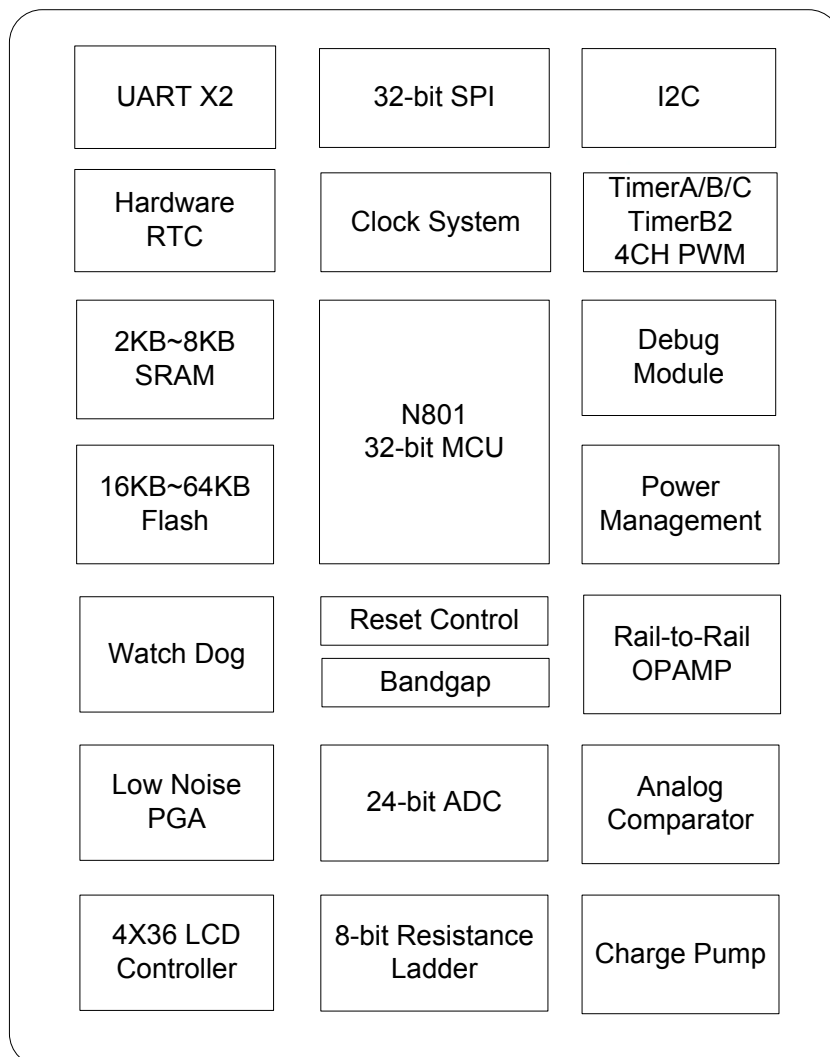

- (01)採用晶心科技 Andes 32 位元 CPU 核心 N801 處理器。
- (02)電壓操作範圍 2.2~3.6V(類比電源沒開啟情況下)，以及-40°C~85°C 工作溫度範圍。
- (03)支援外部 16MHz 石英震盪器或內部 16MHz 高精度 RC 震盪器，
- (04)程式記憶體 64K-Byte Flash ROM
- (05)資料記憶體 8K-Byte SRAM。
- (06)擁有 BOR and WDT 功能，可防止 CPU 死機。
- (07)24-bit 高精準度 $\Sigma \Delta$ ADC 類比數位轉換器
 - (7.1)內置 PGA (Programmable Gain Amplifier)，最大輸入放大倍率高達 128 倍放大。
 - (7.2)內置溫度感測器 TPS。
- (08)內建 1 組 OPA 運算放大器。
- (09)內建硬體 8-bit Resistance Ladder(DAC)。
- (10)16-bit Timer A
- (11)16-bit Timer B/B2 模組具 PWM 波形產生功能
- (12)16-bit Timer C 模組具數位 Capture 功能
- (13)硬體串列通訊 32-bit SPI/I2C/UART*2 模組
- (14)硬體 RTC 時鐘功能模組
- (15)LCD 驅動模組

※中斷副程式型態

Interrupt Vector Address	Vector	Interrupt Function
INT Base Address + 0X00 (I2C/UART/SPI 通訊介面)	HW0	void HW0_ISR(void)
INT Base Address + 0X04 (Timer ABC /WDT/ HW RTC)	HW1	void HW1_ISR(void)
INT Base Address + 0X08 (ADC)	HW2	void HW2_ISR(void)
INT Base Address + 0X0C (CMP/OPA)	HW3	void HW3_ISR(void)
INT Base Address + 0X10 (PT1)	HW4	void HW4_ISR(void)
INT Base Address + 0X14 (PT2)	HW5	void HW5_ISR(void)
INT Base Address + 0X1C (UART2)	HW7	void HW7_ISR(void)
INT Base Address + 0X20 (TMB2)	HW8	void HW8_ISR(void)

3. 數位 IP(Timer)

3.1. 範例名稱

HY16F198B_Timer

3.2. 範例說明

(1)Timer A/Timer B/Timer C 使用方式與說明.

(2)利用程式碼#define 來選擇要編譯執行 TMATEST 或 TMBTEST 或 TMCTEST.

(3)程式做好 Timer 初始化動作與設置相關 Timer 計數溢出值,開啟 System GIE 等待 Timer 中斷發生. Timer 計數溢出值可決定 Timer 進出中斷的速度.

(4)每進一次 Timer 中斷,會在 Timer 中斷副程式內,將所設定的變數 Timer Count 做+1 的動作,並且回到主程式把 Timer Count 顯示在 LCD Display 上.

3.3. 軟體流程

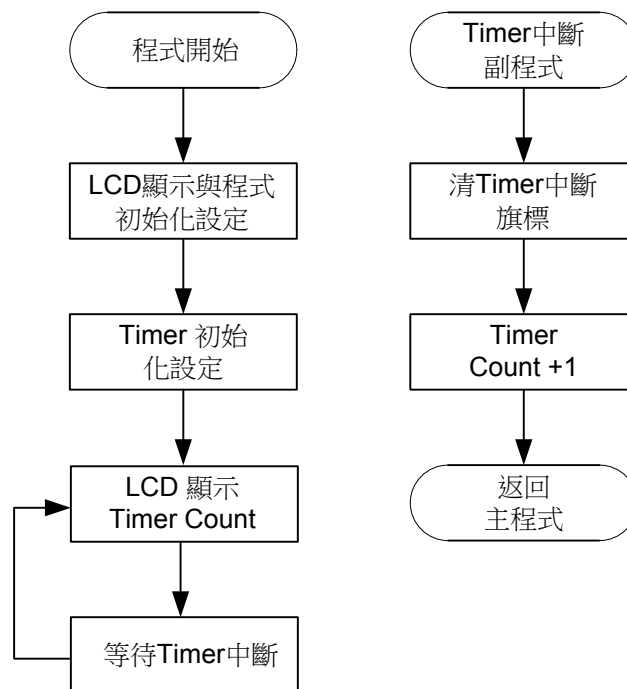

3.4. 程式碼

```
/******  
*  
* Copyright (c) 2016-2026 HYCON Technology, Inc.  
* All rights reserved.  
* HYCON Technology <www.hycontek.com>  
*  
* HYCON reserves the right to amend this code without notice at any time.  
* HYCON assumes no responsibility for any errors appeared in the code,  
* and HYCON disclaims any express or implied warranty, relating to sale  
* and/or use of this code including liability or warranties relating  
* to fitness for a particular purpose, or infringement of any patent,  
* copyright or other intellectual property right.  
*  
* -----  
* Project Name : HY16F198B_Timer  
* IDE tooling : AndeSight C/C++ IDE, version: 2.1.1 Build ID : 201608241332  
* Device Ver. : HY16F_RDSP3_DeviceV0.2 crt0.o for HY16F19xB MCU.  
* Library Ver. : 1.3  
* MCU Device :  
* Description :  
* Created Date : 2018/2/18  
* Created by :  
*  
* Program Description:  
* -----  
*****/  
/*-----*/  
/* Includes */  
/*-----*/  
#include "HY16F198.h"  
#include "System.h"  
#include "DrvClock.h"  
#include "DrvGPIO.h"  
#include "DrvLCD.h"  
#include "DrvREG32.h"
```

```
#include "DrvTimer.h"
#include "Display.h"
#include "my define.h"

/*-----*/
/* STRUCTURES */
/*-----*/
volatile typedef union _MCUSTATUS
{
    char _byte;
    struct
    {
        unsigned b_ADCdone:1;
        unsigned b_TMAdone:1;
        unsigned b_TMBdone:1;
        unsigned b_TMC0done:1;
        unsigned b_TMC1done:1;
        unsigned b_RTCDone:1;
        unsigned b_UART_TxDone:1;
        unsigned b_UART_RxDone:1;
    };
} MCUSTATUS;

/*-----*/
/* Global CONSTANTS */
/*-----*/
MCUSTATUS MCUSTATUSbits;
unsigned int TimerA_count, TimerB_count, TimerC0_count, TimerC1_count;

/*-----*/
/* DEFINITIONS */
/*-----*/
#define TMATEST
//#define TMBTEST
//#define TMCTEST

/*-----*/
/* Function PROTOTYPES */
*/
```

```
/*-----*/
void Delay(unsigned int num);

/*-----*/
/* MAIN function */
/*-----*/
int main(void)
{

    TimerA_count=0;
    TimerB_count=0;
    TimerC0_count=0;
    TimerC1_count=0;
    DisplayInit();
    ClearLCDframe();

#if defined(TMATEST)
    DrvTMA_Open(15,0); //Timer A Overflow
                       //15:taclk/65536/32;TMRDV=---
                       //00:HS_CK

    DrvTIMER_ClearIntFlag(E_TMA); //Clear Timer A interrupt flag
    DrvTIMER_EnableInt(E_TMA); //Timer A interrupt enable
#endif

#if defined(TMBTEST)
    DrvTMBC_Clk_Source(0,3); //Timer B Prescaler 1
                             //0: HS_CK,clock source.
                             //3: clock divider.ur

    DrvTMB_Open(E_TMB_MODE0,E_TMB_NORMAL,0xFFFF); //Timer B overflow 0xffff
    DrvTIMER_ClearIntFlag(E_TMB); //Clear Timer B interrupt flag
    DrvTIMER_EnableInt(E_TMB); //Timer B interrupt enable

#elif defined(TMCTEST)
    DrvTMBC_Clk_Source(0,1); //Timer B Prescaler 1
                             //0: HS_CK,clock source.
                             //1: clock divider.ur
```

```
DrvTMB_Open(E_TMB_MODE0,E_TMB_NORMAL,0xFFFF); //Timer B overflow 0xffff

DrvCapture1_Open(2,14,1); //Timer C0 use as Capture 1
//input source selection
//2:LS_CK
//14:÷16384 1:Rising-edge trigger

DrvCapture2_Open(1,1); //Timer C1 use as Capture 2
//Input source selection
//1:same as Caputre1
//Falling-edge trigger

DrvTIMER_ClearIntFlag(E_TMC0); //Clear TMC0 interrupt flag
DrvTIMER_ClearIntFlag(E_TMC1); //Clear TMC1 interrupt flag
DrvTIMER_EnableInt(E_TMC0); //Timer C0 interrupt enable
DrvTIMER_EnableInt(E_TMC1); //Timer C1 interrupt enable
#endif

SYS_EnableGIE(4,0x1FF); //Enable GIE(Global Interrupt)
MCUSTATUSbits._byte = 0;

while(1) //Wait for Interrupt
{

if(MCUSTATUSbits.b_TMAdone==1)
{
LCD_DATA_DISPLAY(TimerA_count);
MCUSTATUSbits.b_TMAdone=0;
}

if(MCUSTATUSbits.b_TMBdone==1)
{
LCD_DATA_DISPLAY(TimerB_count);
MCUSTATUSbits.b_TMBdone=0;
}

if(MCUSTATUSbits.b_TMC0done==1)
{
```

```
LCD_DATA_DISPLAY(TimerC0_count);
MCUSTATUSbits.b_TMC0done=0;
}

if(MCUSTATUSbits.b_TMC1done==1)
{
LCD_DATA_DISPLAY(TimerC1_count);
MCUSTATUSbits.b_TMC1done=0;
}

}

return 0;
}

/*-----*/
/* Function Name: HW0_ISR() */
/* Description : I2C/UART/SPI interrupt Service Routine (HW0). */
/* Arguments : None. */
/* Return Value : None. */
/* Remark : */
/*-----*/
void HW0_ISR(void)
{

}
/*-----*/
/* Function Name: HW1_ISR() */
/* Description : WDT & RTC & Timer A/B/C interrupt Service Routine (HW1). */
/* Arguments : None. */
/* Return Value : None. */
/* Remark : */
/*-----*/
void HW1_ISR(void)
{
if(DrvTIMER_GetIntFlag(E_TMA))
{
DrvTIMER_ClearIntFlag(E_TMA); // Clear TMA interrupt flag
}
}
}
```

```
MCUSTATUSbits.b_TMAdone=1;
TimerA_count++;
}

if(DrvTIMER_GetIntFlag(E_TMB))
{
    DrvTIMER_ClearIntFlag(E_TMB);           // Clear TMB interrupt flag
    MCUSTATUSbits.b_TMBdone=1;
    TimerB_count++;
}

if(DrvTIMER_GetIntFlag(E_TMC0))
{
    DrvTIMER_ClearIntFlag(E_TMC0);         // Clear TMC0 interrupt flag
    MCUSTATUSbits.b_TMC0done=1;
    TimerC0_count++;
}

if(DrvTIMER_GetIntFlag(E_TMC1))
{
    DrvTIMER_ClearIntFlag(E_TMC1);         // Clear TMC1 interrupt flag
    MCUSTATUSbits.b_TMC1done=1;
    TimerC1_count++;
}
}

/*-----*/
/* Function Name: HW2_ISR()                */
/* Description   : ADC interrupt Service Routine (HW2).                */
/* Arguments     : None.                                                  */
/* Return Value  : None.                                                  */
/* Remark       :                                                         */
/*-----*/
void HW2_ISR(void)
{
}

/*-----*/
/* Function Name: HW3_ISR()                */
```

HY16F19 系列

HYCON IP 使用說明書

```
/* Description   : CMP & OPA interrupt Service Routine (HW3).           */
/* Arguments     : None.                                               */
/* Return Value  : None.                                               */
/* Remark       :                                                       */
/*-----*/
void HW3_ISR(void)
{

}
/*-----*/
/* Function Name: HW4_ISR()                                           */
/* Description   : PT1 interrupt Service Routine (HW4).               */
/* Arguments     : None.                                               */
/* Return Value  : None.                                               */
/* Remark       :                                                       */
/*-----*/
void HW4_ISR(void)
{

}
/*-----*/
/* Function Name: HW5_ISR()                                           */
/* Description   : PT2 interrupt Service Routine (HW5).               */
/* Arguments     : None.                                               */
/* Return Value  : None.                                               */
/* Remark       :                                                       */
/*-----*/
void HW5_ISR(void)
{

}
/*-----*/
/* Function Name: HW7_ISR()                                           */
/* Description   : UART2 interrupt Service Routine (HW7).             */
/* Arguments     : None.                                               */
/* Return Value  : None.                                               */
/* Remark       :                                                       */
/*-----*/
```



```
void HW7_ISR(void)
{

}
/*-----*/
/* Function Name: HW8_ISR() */
/* Description : TMB2 interrupt Service Routine (HW8). */
/* Arguments : None. */
/* Return Value : None. */
/* Remark : */
/*-----*/
void HW8_ISR(void)
{

}
/*-----*/
/* Function Name: tlb_exception_handler() */
/* Description : Exception Service Routines. */
/* Arguments : None. */
/* Return Value : None. */
/* Remark : */
/*-----*/
void tlb_exception_handler()
{
    asm("nop"); //procedure define by customer.
    asm("nop");
}
/*-----*/
/* Software Delay Subroutines */
/*-----*/
void Delay(unsigned int num)
{
    for(;num>0;num--)
        asm("NOP");
}

/*-----*/
/* End Of File */
```

HY16F19 系列 HYCON IP 使用說明書



/*-----*/

4. 數位 IP(WDT)

4.1. 範例名稱

HY16F198B_WDT

4.2. 範例說明

(1)WDT 使用方式與說明

(2)程式做好 WDT 初始化動作與設置 WDT 計數溢出值條件,開啟 System GIE 等待 WDT 中斷發生. WDT 計數溢出值可決定 WDT 進出中斷的速度.

(3)每進一次 WDT 中斷,會在 WDT 中斷副程式內,將所設定的變數 WDTCount 做+1 的動作,並且回到主程式把 WDT Count 顯示在 LCD 上。

4.3. 軟體流程

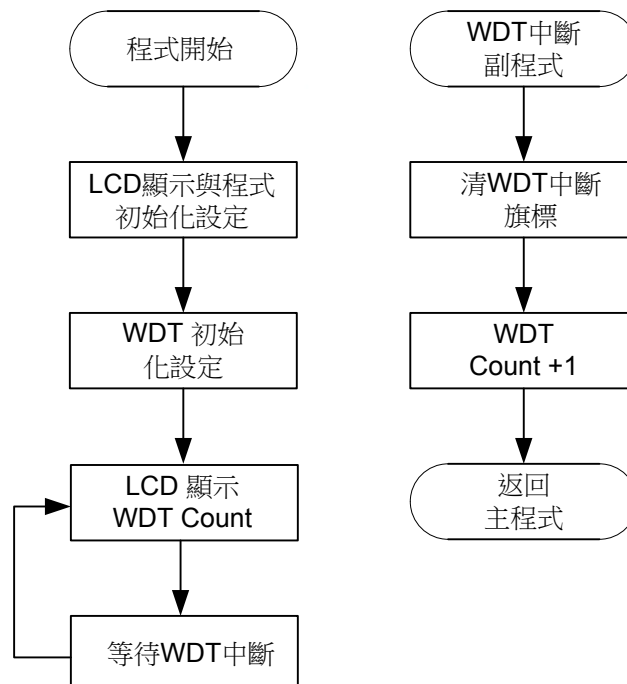

4.4. 程式碼

```
/*
 *
 * Copyright (c) 2016-2026 HYCON Technology, Inc.
 * All rights reserved.
 * HYCON Technology <www.hycontek.com>
 *
 * HYCON reserves the right to amend this code without notice at any time.
 * HYCON assumes no responsibility for any errors appeared in the code,
 * and HYCON disclaims any express or implied warranty, relating to sale
 * and/or use of this code including liability or warranties relating
 * to fitness for a particular purpose, or infringement of any patent,
 * copyright or other intellectual property right.
 *
 * -----
 * Project Name : HY16F198B_WDT
 * IDE tooling : AndeSight C/C++ IDE, version: 2.1.1 Build ID : 201608241332
 * Device Ver. : HY16F_RDSp3_DeviceV0.2 crt0.o for HY16F19xB MCU.
 * Library Ver. : 1.3
 * MCU Device :
 * Description :
 * Created Date : 2018/2/18
 * Created by :
 *
 * Program Description:
 * -----
 */
/*-----*/
/* Includes */
/*-----*/
#include "DrvLCD.h"
#include "DrvREG32.h"
#include "DrvTimer.h"
#include "HY16F198.h"
#include "System.h"
#include "Display.h"
```

HY16F19 系列

HYCON IP 使用說明書

```
/*-----*/
/* STRUCTURES */
/*-----*/
volatile typedef union _MCUSTATUS
{
    char _byte;
    struct
    {
        unsigned b_ADCdone:1;
        unsigned b_TMAdone:1;
        unsigned b_TMBdone:1;
        unsigned b_TMC0done:1;
        unsigned b_WTDone:1;
        unsigned b_RTCDone:1;
        unsigned b_UART_TxDone:1;
        unsigned b_UART_RxDone:1;
    };
} MCUSTATUS;

/*-----*/
/* Global CONSTANTS */
/*-----*/
MCUSTATUS MCUSTATUSbits;
unsigned int WDT_count;

/*-----*/
/* Function PROTOTYPES */
/*-----*/
void Delay(unsigned int num);

/*-----*/
/* MAIN function */
/*-----*/
int main(void)
{

    WDT_count=0;
    DisplayInit();
}
```

```
ClearLCDframe();

DrvWDT_Open(E_IRQ,E_PRE_SCALER_D32); //WDT IRQ open pre scaler 32
DrvWDT_ClearWDT(); //Clear WDT interrupt flag
DrvTIMER_EnableInt(E_WDT); //WDT interrupt enable
SYS_EnableGIE(4,0x1FF); //Enable GIE(Global Interrupt)
MCUSTATUSbits._byte = 0;

while(1) //Wait for WDT Interrupt
{
    if(MCUSTATUSbits.b_WDTdone==1)
    {
        LCD_DATA_DISPLAY(WDT_count);
        MCUSTATUSbits.b_WDTdone=0;
    }
}

return 0;
}

/*-----*/
/* Function Name: HW0_ISR() */
/* Description : I2C/UART/SPI interrupt Service Routine (HW0). */
/* Arguments : None. */
/* Return Value : None. */
/* Remark : */
/*-----*/
void HW0_ISR(void)
{
}

/*-----*/
/* Function Name: HW1_ISR() */
/* Description : WDT & RTC & Timer A/B/C interrupt Service Routine (HW1). */
/* Arguments : None. */
/* Return Value : None. */
/* Remark : */
/*-----*/
```

```
void HW1_ISR(void)
{
    if(DrvTIMER_GetIntFlag(E_WDT))
    {
        WDT_count++;
        MCUSTATUSbits.b_WDTdone=1;
        DrvTIMER_ClearIntFlag(E_WDT);    //Clear WDT interrupt flag
    }
}
/*-----*/
/* Function Name: HW2_ISR()                */
/* Description   : ADC interrupt Service Routine (HW2).                */
/* Arguments    : None.                                                */
/* Return Value : None.                                                */
/* Remark      :                                                         */
/*-----*/
void HW2_ISR(void)
{
}
/*-----*/
/* Function Name: HW3_ISR()                */
/* Description   : CMP & OPA interrupt Service Routine (HW3).          */
/* Arguments    : None.                                                */
/* Return Value : None.                                                */
/* Remark      :                                                         */
/*-----*/
void HW3_ISR(void)
{
}
/*-----*/
/* Function Name: HW4_ISR()                */
/* Description   : PT1 interrupt Service Routine (HW4).                */
/* Arguments    : None.                                                */
/* Return Value : None.                                                */
/* Remark      :                                                         */
/*-----*/
```

```
void HW4_ISR(void)
{

}
/*-----*/
/* Function Name: HW5_ISR() */
/* Description : PT2 interrupt Service Routine (HW5). */
/* Arguments : None. */
/* Return Value : None. */
/* Remark : */
/*-----*/
void HW5_ISR(void)
{

}
/*-----*/
/* Function Name: HW7_ISR() */
/* Description : UART2 interrupt Service Routine (HW7). */
/* Arguments : None. */
/* Return Value : None. */
/* Remark : */
/*-----*/
void HW7_ISR(void)
{

}
/*-----*/
/* Function Name: HW8_ISR() */
/* Description : Timer B2 Interrupt Service Routines (HW8). */
/* Arguments : None. */
/* Return Value : None. */
/* Remark : */
/*-----*/
void HW8_ISR(void)
{

}
/*-----*/
```

HY16F19 系列

HYCON IP 使用說明書

```
/* Function Name: tlb_exception_handler() */
/* Description : Exception Service Routines. */
/* Arguments : None. */
/* Return Value : None. */
/* Remark : */
/*-----*/
void tlb_exception_handler()
{
    asm("nop"); //procedure define by customer.
    asm("nop");
}
/*-----*/
/* Software Delay Subroutines */
/*-----*/
void Delay(unsigned int num)
{
    for(;num>0;num--)
        asm("NOP");
}

/*-----*/
/* End Of File */
/*-----*/
```

5. 數位 IP(WDT Reset)

5.1. 範例名稱

HY16F198B_WDT_Reset

5.2. 範例說明

(1)WDT Reset 使用方式與說明

(2)程式做好 WDT 初始化動作與設置 WDT 計數溢出值條件,開啟 WDT Reset 與 System GIE, 主程式開始計數 WDT Count 並且顯示於 LCD 上, 等待 WDT Reset 發生。

(3)WDT Count 大約計數至 2500~3400 上下, 即會發生 WDT Reset (因為每顆 IC 的高頻 HAO 內震頻率不一樣, 所以 WDT Count 計數到發生 WDT Reset 時間不一定都會相同)。

(4)可透過 PT1.2 按鍵, 清除 WDT 計數暫存器, 並且重新歸零計數 WDT Count, 重新計數 WDT Reset 發生時間。

(5)需注意, 當 WDT Reset Mode 功能開啟之後, 就無法再切換回 WDT Timer Mode

5.3. 軟體流程

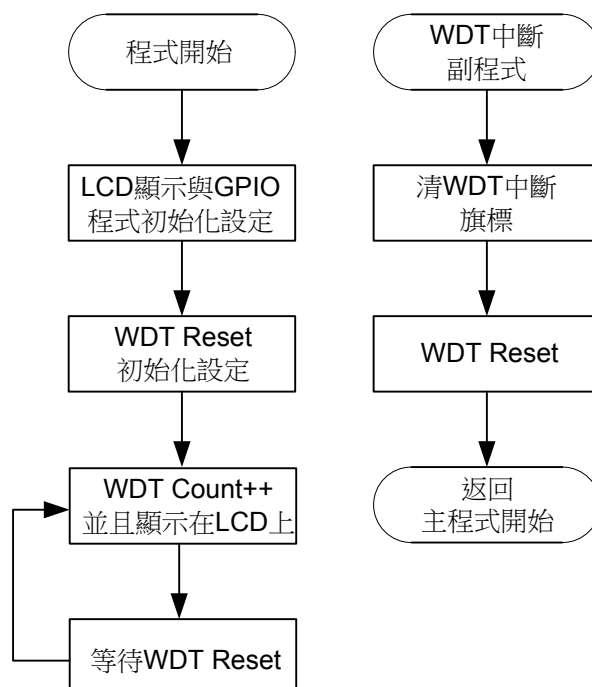

5.4. 程式碼

```
/*
 *
 * Copyright (c) 2016-2026 HYCON Technology, Inc.
 * All rights reserved.
 * HYCON Technology <www.hycontek.com>
 *
 * HYCON reserves the right to amend this code without notice at any time.
 * HYCON assumes no responsibility for any errors appeared in the code,
 * and HYCON disclaims any express or implied warranty, relating to sale
 * and/or use of this code including liability or warranties relating
 * to fitness for a particular purpose, or infringement of any patent,
 * copyright or other intellectual property right.
 *
 * -----
 * Project Name : HY16F198B_WDT_Reset
 * IDE tooling : AndeSight C/C++ IDE, version: 2.1.1 Build ID : 201608241332
 * Device Ver. : HY16F_RDSp3_DeviceV0.2 crt0.o for HY16F19xB MCU.
 * Library Ver. : 1.3
 * MCU Device :
 * Description :
 * Created Date : 2018/2/18
 * Created by :
 *
 * Program Description:
 * -----
 */
/*-----*/
/* Includes */
/*-----*/
#include "DrvLCD.h"
#include "DrvREG32.h"
#include "DrvTimer.h"
#include "HY16F198.h"
#include "System.h"
#include "Display.h"
#include "DrvGPIO.h"
```

```
#include "my define.h"

/*-----*/
/* STRUCTURES                                     */
/*-----*/

volatile typedef union _MCUSTATUS
{
    char _byte;
    struct
    {
        unsigned b_ADCdone:1;
        unsigned b_TMAdone:1;
        unsigned b_TMBdone:1;
        unsigned b_TMC0done:1;
        unsigned b_WTDone:1;
        unsigned b_RTCdone:1;
        unsigned b_UART_TxDone:1;
        unsigned b_UART_RxDone:1;
    };
} MCUSTATUS;

typedef union _PTINTSTATUS
{
    char _byte;
    struct
    {
        unsigned b_PTINT0done:1;
        unsigned b_PTINT1done:1;
        unsigned b_PTINT2done:1;
        unsigned b_PTINT3done:1;
        unsigned b_PTINT4done:1;
        unsigned b_PTINT5done:1;
        unsigned b_PTINT6Done:1;
        unsigned b_PTINT7Done:1;
    };
} PTINTSTATUS;

/*-----*/
/* DEFINITIONS                                     */
/*-----*/
```

```
/*-----*/
#define KEY_PORT E_PT1
#define KEYIN0 BIT1
#define KEYIN1 BIT2
#define KEYIN0_PIN 1
#define KEYIN1_PIN 2

/*-----*/
/* Global CONSTANTS */
/*-----*/
MCUSTATUS  MCUSTATUSbits;
PTINTSTATUS PT1INTSTATUSbits;

/*-----*/
/* Function PROTOTYPES */
/*-----*/
void Delay(unsigned int num);

/*-----*/
/* MAIN function */
/*-----*/
int main(void)
{
    unsigned int WDT_count=0;
    DisplayInit();
    ClearLCDframe();

    DrvWDT_Open(E_NMI,E_PRE_SCALER_D2048);           //WDT IRQ open pre scaler 2048
    DrvWDT_ClearWDT();                               //Clear WDT_count
    DrvWDT_ResetEnable();                            //set WDNMI=1. 0x40108[6]=1b
    DrvGPIO_ClkGenerator(E_HS_CK,1);                 //Set IO sampling clock input source is HS_CK
    DrvGPIO_Open(KEY_PORT,KEYIN1|KEYIN0,E_IO_INPUT); //set PT1.2/PT1.1 INPUT
    DrvGPIO_Open(KEY_PORT,KEYIN1|KEYIN0,E_IO_PullHigh); //enable PT1.2/PT1.1 pull high R
    DrvGPIO_Open(KEY_PORT,KEYIN1|KEYIN0,E_IO_IntEnable); //PT1.2/PT1.1 interrupt enable
    DrvGPIO_IntTrigger(KEY_PORT,KEYIN1|KEYIN0,E_N_Edge); //PT1.2/PT1.1 interrupt trigger method is negative edge
    DrvGPIO_ClearIntFlag(KEY_PORT,KEYIN1|KEYIN0);   //clear PT1 interrupt flag
    MCUSTATUSbits._byte = 0;
}
```

```

PT1INTSTATUSbits._byte = 0;
SYS_EnableGIE(4,0x1FF); //Enable GIE(Global Interrupt)

while(1)
{
    for(WDT_count=0;WDT_count<999999;WDT_count++)
    {
        LCD_DATA_DISPLAY(WDT_count); //WDT Reset occur on about WDT_count=2500~3500, it
depends on the HAO frequency
        Delay(1000);
        if(PT1INTSTATUSbits.b_PTINT1done) //if PT1.2 low
        {
            WDT_count=0; //Set WDT_count=0,
            DrvWDT_ClearWDT(); //WDT re-count again, start from 0 to count
            PT1INTSTATUSbits.b_PTINT1done=0;
        }
    }
}

return 0;
}
/*-----*/
/* Function Name: HW0_ISR() */
/* Description : I2C/UART/SPI interrupt Service Routine (HW0). */
/* Arguments : None. */
/* Return Value : None. */
/* Remark : */
/*-----*/
void HW0_ISR(void)
{
}
/*-----*/
/* Function Name: HW1_ISR() */
/* Description : WDT & RTC & Timer A/B/C interrupt Service Routine (HW1). */
/* Arguments : None. */
/* Return Value : None. */

```

```
/* Remark      :                                          */
/*-----*/
void HW1_ISR(void)
{
    if(DrvTIMER_GetIntFlag(E_WDT))
    {
        MCUSTATUSbits.b_WDTdone=1;
        DrvTIMER_ClearIntFlag(E_WDT);           //Clear WDT interrupt flag
    }
}
/*-----*/
/* Function Name: HW2_ISR()                               */
/* Description   : ADC interrupt Service Routine (HW2).   */
/* Arguments    : None.                                   */
/* Return Value : None.                                   */
/* Remark      :                                          */
/*-----*/
void HW2_ISR(void)
{
}
/*-----*/
/* Function Name: HW3_ISR()                               */
/* Description   : CMP & OPA interrupt Service Routine (HW3). */
/* Arguments    : None.                                   */
/* Return Value : None.                                   */
/* Remark      :                                          */
/*-----*/
void HW3_ISR(void)
{
}
/*-----*/
/* Function Name: HW4_ISR()                               */
/* Description   : PT1 interrupt Service Routine (HW4).   */
/* Arguments    : None.                                   */
/* Return Value : None.                                   */
/* Remark      :                                          */
```

HY16F19 系列

HYCON IP 使用說明書

```
/*-----*/
/* Function Name: HW8_ISR() */
/* Description : Timer B2 Interrupt Service Routines (HW8). */
/* Arguments : None. */
/* Return Value : None. */
/* Remark : */
/*-----*/
void HW8_ISR(void)
{

}
/*-----*/
/* Function Name: tlb_exception_handler() */
/* Description : Exception Service Routines. */
/* Arguments : None. */
/* Return Value : None. */
/* Remark : */
/*-----*/
void tlb_exception_handler()
{
    asm("nop"); //procedure define by customer.
    asm("nop");
}
/*-----*/
/* Software Delay Subroutines */
/*-----*/
void Delay(unsigned int num)
{
    for(;num>0;num--)
        asm("NOP");
}
/*-----*/
/* End Of File */
/*-----*/
```

6. 數位 IP(RTC)

6.1. 範例名稱

HY16F198B_RTC

6.2. 範例說明

(1)RTC 使用方式與說明

(2)利用程式碼#define 來選擇要編譯執行 RTC_counter_show 或 TimerDdata_show.

(3)程式做好 RTC 初始化動作與設置 RTC 計數溢出值條件,開啟 System GIE, 等待 RTC 中斷發生.

(4)當選擇 RTC_counter_show, LCD 會顯示 RTC 進入中斷之後的每一次 RTC Count 計數+1, RTC Count 從 0 開始計數, 當選擇 TimerDdata_show, LCD 會顯示程式中所設置的時間, 每進一次 RTC 中斷, 時間會往上數 1 秒.

6.3. 軟體流程

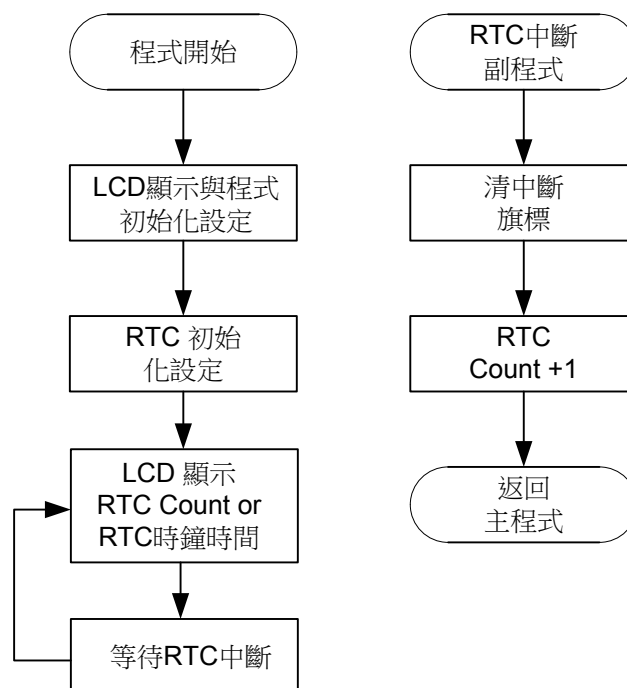

6.4. 程式碼

```
/******  
*  
* Copyright (c) 2016-2026 HYCON Technology, Inc.  
* All rights reserved.  
* HYCON Technology <www.hycontek.com>  
*  
* HYCON reserves the right to amend this code without notice at any time.  
* HYCON assumes no responsibility for any errors appeared in the code,  
* and HYCON disclaims any express or implied warranty, relating to sale  
* and/or use of this code including liability or warranties relating  
* to fitness for a particular purpose, or infringement of any patent,  
* copyright or other intellectual property right.  
*  
* -----  
* Project Name : HY16F198B_RTC  
* IDE tooling : AndeSight C/C++ IDE, version: 2.1.1 Build ID : 201608241332  
* Device Ver. : HY16F_RDSP3_DeviceV0.2 crt0.o for HY16F19xB MCU.  
* Library Ver. : 1.3  
* MCU Device :  
* Description :  
* Created Date : 2018/2/18  
* Created by :  
*  
* Program Description:  
* -----  
*****/  
/*-----*/  
/* Includes */  
/*-----*/  
#include "HY16F198.h"  
#include "System.h"  
#include "DrvClock.h"  
#include "DrvGPIO.h"  
#include "DrvLCD.h"  
#include "DrvREG32.h"  
#include "DrvRTC.h"
```

```
#include "Display.h"

/*-----*/
/* STRUCTURES */
/*-----*/
volatile typedef union _MCUSTATUS
{
    char _byte;
    struct
    {
        unsigned b_ADCdone:1;
        unsigned b_TMAdone:1;
        unsigned b_TMBdone:1;
        unsigned b_TMC0done:1;
        unsigned b_TMC1done:1;
        unsigned b_RTCdone:1;
        unsigned b_UART_TxDone:1;
        unsigned b_UART_RxDone:1;
    };
} MCUSTATUS;

/*-----*/
/* Global CONSTANTS */
/*-----*/
MCUSTATUS MCUSTATUSbits;
unsigned int sec,min,hour,week,day,month,year ;
unsigned int RTC_counter;
unsigned int TimerDtata;
/*-----*/
/* DEFINITIONS */
/*-----*/
#define RTC_counter_show
#define TimerDtata_show

/*-----*/
/* Function PROTOTYPES */
/*-----*/
void Delay(unsigned int num);
```

```
void InitalRTC(void);
int ComputeWeek(int TempYear, int TempMonth, int TempDay);

/*-----*/
/* MAIN function */
/*-----*/
int main(void)
{

    S_DRVRTC_TIME_DATA_T sCurTime;    //Setting Start
    RTC_counter=0;
    TimerDtata=0;

    DisplayInit();
    ClearLCDframe();
    InitalRTC();
    MCUSTATUSbits._byte = 0;
    SYS_EnableGIE(4,0x1FF);          //Enable GIE(Global Interrupt)

    while(1)
    {
        if(MCUSTATUSbits.b_RTCdone==1)
        {
            DrvRTC_Read(DRVRTC_CURRENT_TIME,&sCurTime);
            TimerDtata=sCurTime.u32cSecond+sCurTime.u32cMinute*100+sCurTime.u32cHour*10000;
#ifdef TimerDtata_show
            LCD_DATA_DISPLAY(TimerDtata);
#endif
#ifdef RTC_counter_show
            LCD_DATA_DISPLAY(RTC_counter);
#endif

            sec=sCurTime.u32cSecond;
            min=sCurTime.u32cMinute;
            hour=sCurTime.u32cHour;
            week=sCurTime.u32cDayOfWeek;
            day=sCurTime.u32cDay;
            month=sCurTime.u32cMonth;
```

```
    year=sCurTime.u32Year;
    MCUSTATUSbits.b_RTCdone=0;
}
}

return 0;
}

/*-----*/
/* Function Name: HW0_ISR() */
/* Description : I2C/UART/SPI interrupt Service Routine (HW0). */
/* Arguments : None. */
/* Return Value : None. */
/* Remark : */
/*-----*/
void HW0_ISR(void)
{
}
/*-----*/
/* Function Name: HW1_ISR() */
/* Description : WDT & RTC & Timer A/B/C interrupt Service Routine (HW1). */
/* Arguments : None. */
/* Return Value : None. */
/* Remark : */
/*-----*/
void HW1_ISR(void)
{
    if(DrvRTC_ReadState()&&0x2) //check PTF flag
    {
        DrvRTC_ClearState(E_DRVRTC_CLEAR_ALL);
        DrvRTC_ClearIntFlag();
        RTC_counter++;
        MCUSTATUSbits.b_RTCdone=1;
    }
}
/*-----*/
/* Function Name: HW2_ISR() */
```

HY16F19 系列

HYCON IP 使用說明書

```
/* Description   : ADC interrupt Service Routine (HW2).           */
/* Arguments    : None.                                         */
/* Return Value : None.                                         */
/* Remark      :                                               */
/*-----*/
void HW2_ISR(void)
{

}
/*-----*/
/* Function Name: HW3_ISR()                                     */
/* Description   : CMP & OPA interrupt Service Routine (HW3).   */
/* Arguments    : None.                                         */
/* Return Value : None.                                         */
/* Remark      :                                               */
/*-----*/
void HW3_ISR(void)
{

}
/*-----*/
/* Function Name: HW4_ISR()                                     */
/* Description   : PT1 interrupt Service Routine (HW4).         */
/* Arguments    : None.                                         */
/* Return Value : None.                                         */
/* Remark      :                                               */
/*-----*/
void HW4_ISR(void)
{

}
/*-----*/
/* Function Name: HW5_ISR()                                     */
/* Description   : PT2 interrupt Service Routine (HW5).         */
/* Arguments    : None.                                         */
/* Return Value : None.                                         */
/* Remark      :                                               */
/*-----*/
```

```
void HW5_ISR(void)
{

}
/*-----*/
/* Function Name: HW7_ISR() */
/* Description : UART2 interrupt Service Routine (HW7). */
/* Arguments : None. */
/* Return Value : None. */
/* Remark : */
/*-----*/
void HW7_ISR(void)
{

}
/*-----*/
/* Function Name: HW8_ISR() */
/* Description : TMB2 interrupt Service Routine (HW8). */
/* Arguments : None. */
/* Return Value : None. */
/* Remark : */
/*-----*/
void HW8_ISR(void)
{

}
/*-----*/
/* Function Name: tlb_exception_handler() */
/* Description : Exception Service Routines. */
/* Arguments : None. */
/* Return Value : None. */
/* Remark : */
/*-----*/
void tlb_exception_handler()
{
    asm("nop"); //procedure define by customer.
    asm("nop");
}
```



```
/*-----*/
/* Function Name: InitalRTC() */
/* Description : RTC Initialization Subroutines. */
/* Arguments : None. */
/* Return Value : None. */
/* Remark : */
/*-----*/

void InitalRTC()
{
    S_DRVRTC_TIME_DATA_T sCurTime; //Setting Start
    DrvRTC_ClkConfig(1);
    DrvCLOCK_EnableLowOSC(E_EXTERNAL,130000);
    DrvRTC_ClockSource(0); //RTC clock source =LSXT

    //DRVRTC_CURRENT_TIME or Alarm Time
    DrvRTC_WriteEnable();
    DrvRTC_Read(DRVRTC_CURRENT_TIME,&sCurTime);
    sCurTime.u8cClockDisplay=0; //DRVRTC_CLOCK_12//DRVRTC_CLOCK_24
    sCurTime.u8cAmPm=0; //DRVRTC_AM//DRVRTC_PM
    sCurTime.u32cSecond=40;
    sCurTime.u32cMinute=59;
    sCurTime.u32cHour=23;
    sCurTime.u32cDay=18;
    sCurTime.u32cMonth=2;
    sCurTime.u32Year=2018;
    sCurTime.u32cDayOfWeek=ComputeWeek(sCurTime.u32Year,sCurTime.u32cMonth,sCurTime.u32cDay);
    sCurTime.u8IsEnableWakeUp=0; //WK
    DrvRTC_Write(DRVRTC_CURRENT_TIME,&sCurTime);
    DrvRTC_HourFormat(E_DRVRTC_HOUR_24); //1:12hour 0:24hour
    DrvRTC_Enable();
    DrvRTC_PeriodicTimeEnable(E_DRVRTC_1_8_SEC);
    DrvRTC_ClearIntFlag();
    DrvRTC_EnableInt(); //Enable RTC interrupt
}

/*-----*/
/* Compute Week Subroutines */
```

```
/*-----*/
int ComputeWeek(int TempYear, int TempMonth, int TempDay)
{
    int TempWeek;
    if (TempMonth >= 3)
    {
        TempMonth = TempMonth - 2;
    }
    else
    {
        TempMonth = TempMonth + 10;
        TempYear--;
    }

    TempWeek = TempYear + (int)(TempYear / 4) - (int)(TempYear / 100) + (int)(TempYear / 400) + (int)(2.6 * TempMonth - 0.2) +
    TempDay;
    TempWeek = TempWeek - 7*(int)(TempWeek / 7);
    return (TempWeek);
}

/*-----*/
/* Software Delay Subroutines */
/*-----*/
void Delay(unsigned int num)
{
    for(;num>0;num--)
        asm("NOP");
}

/*-----*/
/* End Of File */
/*-----*/
```

7. 數位 IP(PWM)

7.1. 範例名稱

HY16F198B_PWM

7.2. 範例說明

- (1) PWM 使用方式與說明
- (2) 程式初始先設置 HAO 工作頻率與 TimerB 計數溢出值條件
- (3) 開啟 PWM 暫存器設定與 PWM Duty 設定,再將要執行 PWM 輸出的 I/O 設置為輸出模式.
- (4) 可在 PT2.0 與 PT2.1 觀察到 PWM 波型, PT2.0 為 PWM0, PT2.1 為 PWM1.

7.3. 軟體流程

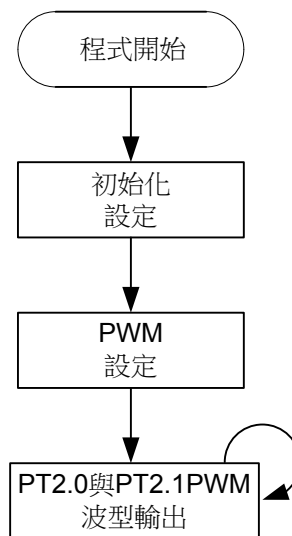

7.4. 程式碼

```
/******  
*  
* Copyright (c) 2016-2026 HYCON Technology, Inc.  
* All rights reserved.  
* HYCON Technology <www.hycontek.com>  
*  
* HYCON reserves the right to amend this code without notice at any time.  
* HYCON assumes no responsibility for any errors appeared in the code,  
* and HYCON disclaims any express or implied warranty, relating to sale  
* and/or use of this code including liability or warranties relating  
* to fitness for a particular purpose, or infringement of any patent,  
* copyright or other intellectual property right.  
*  
* -----  
* Project Name : HY16F198B_PWM  
* IDE tooling : AndeSight C/C++ IDE, version: 2.1.1 Build ID : 201608241332  
* Device Ver. : HY16F_RDSP3_DeviceV0.2 crt0.o for HY16F19xB MCU.  
* Library Ver. : 1.3  
* MCU Device :  
* Description :  
* Created Date : 2018/2/18  
* Created by :  
*  
* Program Description:  
* -----  
*****/  
/*-----*/  
/* Includes */  
/*-----*/  
#include "DrvClock.h"  
#include "DrvGPIO.h"  
#include "DrvPMU.h"  
#include "HY16F198.h"  
#include "System.h"  
#include "DrvTimer.h"
```

```
/*-----*/
/* Global CONSTANTS                                     */
/*-----*/

/*-----*/
/* Function PROTOTYPES                                 */
/*-----*/
void Delay(unsigned int num);

/*-----*/
/* MAIN function                                       */
/*-----*/
int main(void)
{
    DrvCLOCK_SelectIHOSC(1);           // Select HAO 4MHz
    DrvCLOCK_EnableHighOSC(E_INTERNAL,10);
    SYS_DisableGIE();                 //Disable GIE

    DrvPWM0_Open(0,1,2);               //PWM0 Enable Port 2.0 =PWMO0, Port 2.1 =PWM01(Set PWM0=PT2.0)
    DrvPWM1_Open(1,1,2);               //PWM1 Enable Port 2.0 =PWMO0, Port 2.1 =PWM01(Set PWM1=PT2.1)
    DrvPWM_CountCondition(0x7fff,0x3fff); //PWM0 Duty 0X7FFF, PWM0=PT2.0
                                         //PWM1 Duty 0X3FFF, PWM1=PT2.1

    DrvGPIO_Open(E_PT2,0x0110x02,E_IO_OUTPUT); //PT2.0, PT2.1 Set Output
    DrvTMBC_Clk_Source(0,0);           //TMB Clock Enable/1
    DrvTMB_Open(E_TMB_MODE0,E_TMB_NORMAL,0xffff); //TMB Overflow 0XFFFF
                                         //PWM Period 0XFFFF

    while(1);
}

/*-----*/
/* Function Name: HW0_ISR                                */
/* Description   : I2C/UART/SPI interrupt Service Routine (HW0). */
/* Arguments    : None.                                     */
/* Return Value : None.                                     */
/* Remark      :                                           */
/*-----*/
void HW0_ISR(void)
{
```

```
}
/*-----*/
/* Function Name: HW1_ISR() */
/* Description : WDT & RTC & Timer A/B/C interrupt Service Routine (HW1). */
/* Arguments : None. */
/* Return Value : None. */
/* Remark : */
/*-----*/
void HW1_ISR(void)
{

}
/*-----*/
/* Function Name: HW2_ISR() */
/* Description : ADC interrupt Service Routine (HW2). */
/* Arguments : None. */
/* Return Value : None. */
/* Remark : */
/*-----*/
void HW2_ISR(void)
{

}
/*-----*/
/* Function Name: HW3_ISR() */
/* Description : CMP & OPA interrupt Service Routine (HW3). */
/* Arguments : None. */
/* Return Value : None. */
/* Remark : */
/*-----*/
void HW3_ISR(void)
{

}
/*-----*/
/* Function Name: HW4_ISR() */
/* Description : PT1 interrupt Service Routine (HW4). */
```

HY16F19 系列

HYCON IP 使用說明書

```
/* Arguments      : None.                */
/* Return Value : None.                */
/* Remark        :                       */
/*-----*/
void HW4_ISR(void)
{

}
/*-----*/
/* Function Name: HW5_ISR()             */
/* Description   : PT2 interrupt Service Routine (HW5). */
/* Arguments    : None.                */
/* Return Value : None.                */
/* Remark      :                       */
/*-----*/
void HW5_ISR(void)
{

}
/*-----*/
/* Function Name: HW7_ISR()             */
/* Description   : UART2 interrupt Service Routine (HW7). */
/* Arguments    : None.                */
/* Return Value : None.                */
/* Remark      :                       */
/*-----*/
void HW7_ISR(void)
{

}
/*-----*/
/* Function Name: HW8_ISR()             */
/* Description   : TMB2 interrupt Service Routine (HW8). */
/* Arguments    : None.                */
/* Return Value : None.                */
/* Remark      :                       */
/*-----*/
void HW8_ISR(void)
```

```
{  
  
}  
/*-----*/  
/* Function Name: tlb_exception_handler() */  
/* Description : Exception Service Routines. */  
/* Arguments : None. */  
/* Return Value : None. */  
/* Remark : */  
/*-----*/  
void tlb_exception_handler()  
{  
    asm("nop"); //procedure define by customer.  
    asm("nop");  
}  
/*-----*/  
/* Software Delay Subroutines */  
/*-----*/  
void Delay(unsigned int num)  
{  
    for(;num>0;num--)  
        asm("NOP");  
}  
  
/*-----*/  
/* End Of File */  
/*-----*/
```

8. 數位 IP(Flash)

8.1. 範例名稱

HY16F198B_Flash

8.2. 範例說明

(1) Flash 自我燒錄與讀取使用說明

(2) 第一段的程式範例先執行一整個 Page 的自我燒錄並讀回做驗證, 如果寫入與讀回的內容不相同, LCD 會顯示” 1” 並且程式卡在 While(1).

(3) 第二段的程式範例執行一個 Word 的自我燒錄並讀回做驗證, 如果寫入與讀回的內容不相同, 則設計程式卡在 While(1).

注意1：在執行Flash燒錄與讀取程式指令之前, 必須先執行SYS_DisableGIE(); 關閉全域使能中斷, 這可以避免程式運行異常的行為發生.

注意2：執行Flash燒錄指令, 必須確保晶片工作電壓VDD3V高於2.7V, 如果晶片電壓VDD3V低於2.7V, 則可能會發生燒錄錯誤行為.

8.3. 程式碼

```
/*  
*****  
*/
```

```
*  
* Copyright (c) 2016-2026 HYCON Technology, Inc.  
* All rights reserved.  
* HYCON Technology <www.hycontek.com>  
*  
* HYCON reserves the right to amend this code without notice at any time.  
* HYCON assumes no responsibility for any errors appeared in the code,  
* and HYCON disclaims any express or implied warranty, relating to sale  
* and/or use of this code including liability or warranties relating  
* to fitness for a particular purpose, or infringement of any patent,  
* copyright or other intellectual property right.  
*  
* -----  
* Project Name : HY16F198B_Flash  
* IDE tooling : AndeSight C/C++ IDE, version: 2.1.1 Build ID : 201608241332  
* Device Ver. : HY16F_RDSp3_DeviceV0.2 crt0.o for HY16F19xB MCU.  
* Library Ver. : 1.3
```

* MCU Device :

* Description :

* Created Date : 2018/2/18

* Created by :

*

* Program Description:

* -----

*****/

/*-----*/

/* Includes */

/*-----*/

#include "DrvFlash.h"

#include "DrvREG32.h"

#include "HY16F198.h"

#include "Display.h"

#include "system.h"

/*-----*/

/* Global CONSTANTS */

/*-----*/

/*-----*/

/* Function PROTOTYPES */

/*-----*/

void Delay(unsigned int num);

/*-----*/

/* Main Function */

/*-----*/

int main(void)

{

 unsigned char index,error;

 int BufferTx[32];

 int BufferRx[32];

 DisplayInit();

 ClearLCDframe();

 Delay(10000);

```
DisplayHYcon();
Delay(10000);

SYS_DisableGIE(); //before execute Flash burn, must be to do that Disable GIE

for(index=0;index<32;index++)
{
    BufferTx[index]=index; //to set BufferTx[0]=0x0....BufferTx[31]=0x1f
    BufferRx[index]=0xFFFFFFFF; //to set BufferRx[0]=0xFFFFFFFF....BufferRx[31]=0xFFFFFFFF
}
ROM_BurnPage(0x8000,0x2000,BufferTx);
ReadPage(0x8000,BufferRx); //Read BufferRx to make sure BurnPage data

for(index=0;index<32;index++)
{
    BufferTx[index]=31-index; //to set BufferTx[0]=0x1f....BufferTx[31]=0x0
    BufferRx[index]=0xFFFFFFFF; //to set BufferRx[0]=0xFFFFFFFF....BufferRx[31]=0xFFFFFFFF
}
ROM_BurnPage(0x8000,0x2000,BufferTx);
ReadPage(0x8000,BufferRx); //Read BufferRx to make sure BurnPage data

//verify the ROM_BurnPage function, if fail to show "1" on the LCD Display
for(index=0;index<32;index++)
{
    if(BufferTx[index]!=BufferRx[index])
    {
        LCD_DATA_DISPLAY(1);
        while(1);
    }
}

error=DrvFlash_Burn_Word(0x8014,0x2000,0x12345678);
if(error==0) //if Error=0, it means BurnWord success
    ReadPage(0x8014,BufferRx);

error=DrvFlash_Burn_Word(0x8010,0x2000,0x12345678);
if(error==0) //if Error=0, it means BurnWord success
    ReadPage(0x8010,BufferRx);
```

```
error=DrvFlash_Burn_Word(0x8020,0x2000,0x12345678);
if(error==0) //if Error=0, it means BurnWord success
    ReadPage(0x8020,BufferRx);

while(1);
return 0;
}

/*-----*/
/* Function Name: HW0_ISR() */
/* Description : I2C/UART/SPI interrupt Service Routine (HW0). */
/* Arguments : None. */
/* Return Value : None. */
/* Remark : */
/*-----*/
void HW0_ISR(void)
{

}
/*-----*/
/* Function Name: HW1_ISR() */
/* Description : WDT & RTC & Timer A/B/C interrupt Service Routine (HW1). */
/* Arguments : None. */
/* Return Value : None. */
/* Remark : */
/*-----*/
void HW1_ISR(void)
{

}
/*-----*/
/* Function Name: HW2_ISR() */
/* Description : ADC interrupt Service Routine (HW2). */
/* Arguments : None. */
/* Return Value : None. */
/* Remark : */
/*-----*/
```

```
void HW2_ISR(void)
{

}
/*-----*/
/* Function Name: HW3_ISR() */
/* Description : CMP & OPA interrupt Service Routine (HW3). */
/* Arguments : None. */
/* Return Value : None. */
/* Remark : */
/*-----*/
void HW3_ISR(void)
{

}
/*-----*/
/* Function Name: HW4_ISR() */
/* Description : PT1 interrupt Service Routine (HW4). */
/* Arguments : None. */
/* Return Value : None. */
/* Remark : */
/*-----*/
void HW4_ISR(void)
{

}
/*-----*/
/* Function Name: HW5_ISR() */
/* Description : PT2 interrupt Service Routine (HW5). */
/* Arguments : None. */
/* Return Value : None. */
/* Remark : */
/*-----*/
void HW5_ISR(void)
{

}
/*-----*/
```

HY16F19 系列

HYCON IP 使用說明書

```
/* Function Name: HW7_ISR() */
/* Description : UART2 interrupt Service Routine (HW7). */
/* Arguments : None. */
/* Return Value : None. */
/* Remark : */
/*-----*/
void HW7_ISR(void)
{

}
/*-----*/

/* Function Name: HW8_ISR() */
/* Description : TMB2 interrupt Service Routine (HW8). */
/* Arguments : None. */
/* Return Value : None. */
/* Remark : */
/*-----*/
void HW8_ISR(void)
{

}
/*-----*/

/* Function Name: tlb_exception_handler() */
/* Description : Exception Service Routines. */
/* Arguments : None. */
/* Return Value : None. */
/* Remark : */
/*-----*/
void tlb_exception_handler()
{
    asm("nop"); //procedure define by customer.
    asm("nop");
}
/*-----*/

/* Software Delay Subroutines */
/*-----*/
void Delay(unsigned int num)
{
```

```
for(;num>0;num--)  
asm("NOP");  
}
```

```
/*-----*/
```

```
/* End Of File
```

```
*/
```

```
/*-----*/
```

9. 數位 IP(GPIO)

9.1. 範例名稱

HY16F198B_GPIO

9.2. 範例說明

- (1) GPIO 使用範例程式.
- (2)程式初始化 GPIO 相關設置與 LCD 設置.
- (3)每按一次 PT1.1,變數 count+1, LCD 顯示 count 數值
- (4)每按一次 PT1.2,變數 count-1, LCD 顯示 count 數值

9.3. 軟體流程

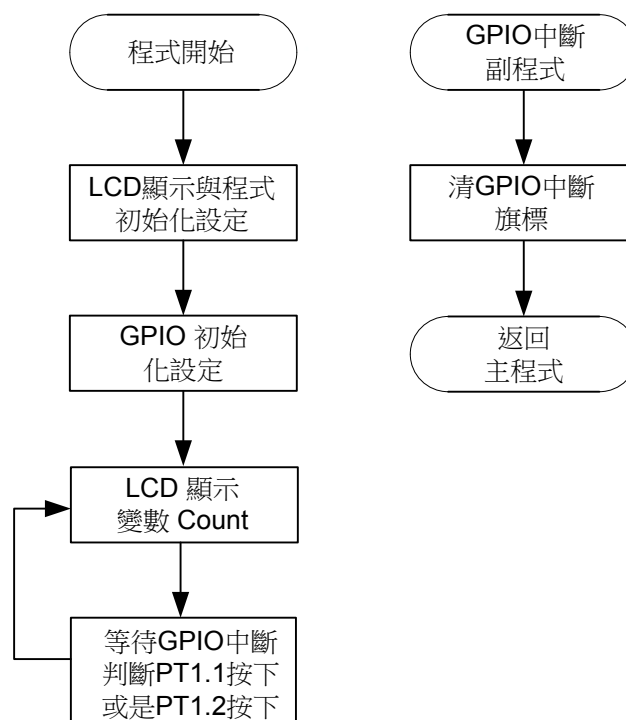

9.4. 程式碼

```
/*
 *
 * Copyright (c) 2016-2026 HYCON Technology, Inc.
 * All rights reserved.
 * HYCON Technology <www.hycontek.com>
 *
 * HYCON reserves the right to amend this code without notice at any time.
 * HYCON assumes no responsibility for any errors appeared in the code,
 * and HYCON disclaims any express or implied warranty, relating to sale
 * and/or use of this code including liability or warranties relating
 * to fitness for a particular purpose, or infringement of any patent,
 * copyright or other intellectual property right.
 *
 * -----
 * Project Name : HY16F198B_GPIO
 * IDE tooling : AndeSight C/C++ IDE, version: 2.1.1 Build ID : 201608241332
 * Device Ver. : HY16F_RDSp3_DeviceV0.2 crt0.o for HY16F19xB MCU.
 * Library Ver. : 1.3
 * MCU Device :
 * Description :
 * Created Date : 2018/2/18
 * Created by :
 *
 * Program Description:
 * -----
 */
/*-----*/
/* Includes */
/*-----*/

#include "DrvClock.h"
#include "DrvGPIO.h"
#include "DrvLCD.h"
#include "HY16F198.h"
#include "ModuleID.h"
#include "System.h"
```

```
#include "Display.h"
#include "my define.h"

/*-----*/
/* STRUCTURES */
/*-----*/

typedef union _MCUSTATUS
{
    char _byte;
    struct
    {
        unsigned b_ADCdone:1;
        unsigned b_TMAdone:1;
        unsigned b_TMBdone:1;
        unsigned b_TMC0done:1;
        unsigned b_TMC1done:1;
        unsigned b_RTCdone:1;
        unsigned b_UART_TxDone:1;
        unsigned b_UART_RxDone:1;
    };
} MCUSTATUS;

volatile typedef union _PTINTSTATUS
{
    char _byte;
    struct
    {
        unsigned b_PTINT0done:1;
        unsigned b_PTINT1done:1;
        unsigned b_PTINT2done:1;
        unsigned b_PTINT3done:1;
        unsigned b_PTINT4done:1;
        unsigned b_PTINT5done:1;
        unsigned b_PTINT6Done:1;
        unsigned b_PTINT7Done:1;
    };
} PTINTSTATUS;
```

```
/*-----*/
/* DEFINITIONS */
/*-----*/

#define KEY_PORT E_PT1
#define KEYIN0 BIT1
#define KEYIN1 BIT2
#define KEYIN0_PIN 1
#define KEYIN1_PIN 2

/*-----*/
/* Global CONSTANTS */
/*-----*/

PTINTSTATUS PT1INTSTATUSbits;

/*-----*/
/* Function PROTOTYPES */
/*-----*/

void Delay(unsigned int num);

/*-----*/
/* MAIN function */
/*-----*/

int main(void)
{

    int count=0;
    DisplayInit();
    ClearLCDframe();
    LCD_DATA_DISPLAY(count);

    DrvGPIO_ClkGenerator(E_HS_CK,1); //Set IO sampling clock input source is HS_CK
    DrvGPIO_Open(KEY_PORT,KEYIN1|KEYIN0,E_IO_INPUT); //set PT1.2/PT1.1 INPUT
    DrvGPIO_Open(KEY_PORT,KEYIN1|KEYIN0,E_IO_PullHigh); //enable PT1.2/PT1.1 pull high R
    DrvGPIO_Open(KEY_PORT,KEYIN1|KEYIN0,E_IO_IntEnable); //PT1.2/PT1.1 interrupt enable
    DrvGPIO_IntTrigger(KEY_PORT,KEYIN1|KEYIN0,E_N_Edge); //PT1.2/PT1.1 interrupt trigger method is negative edge
    DrvGPIO_ClearIntFlag(KEY_PORT,KEYIN1|KEYIN0); //clear PT1 interrupt flag

    PT1INTSTATUSbits._byte = 0;
```

```
SYS_EnableGIE(4,0x1FF); //Enable GIE(Global Interrupt)

while(1)
{
    if(PT1INTSTATUSbits.b_PTINT1done) //if PT1.1 low
    {
        LCD_DATA_DISPLAY(count++);
        PT1INTSTATUSbits.b_PTINT1done=0;
    }
    if(PT1INTSTATUSbits.b_PTINT2done) //if PT1.2 low
    {
        LCD_DATA_DISPLAY(count--);
        PT1INTSTATUSbits.b_PTINT2done=0;
    }
}

return 0;
}

/*-----*/
/* Function Name: HW0_ISR() */
/* Description : I2C/UART/SPI interrupt Service Routine (HW0). */
/* Arguments : None. */
/* Return Value : None. */
/* Remark : */
/*-----*/
void HW0_ISR(void)
{
}

/*-----*/
/* Function Name: HW1_ISR() */
/* Description : WDT & RTC & Timer A/B/C interrupt Service Routine (HW1). */
/* Arguments : None. */
/* Return Value : None. */
/* Remark : */
/*-----*/
void HW1_ISR(void)
```

```
{

}

/*-----*/
/* Function Name: HW2_ISR() */
/* Description : ADC interrupt Service Routine (HW2). */
/* Arguments : None. */
/* Return Value : None. */
/* Remark : */
/*-----*/
void HW2_ISR(void)
{

}
/*-----*/
/* Function Name: HW3_ISR() */
/* Description : CMP & OPA interrupt Service Routine (HW3). */
/* Arguments : None. */
/* Return Value : None. */
/* Remark : */
/*-----*/
void HW3_ISR(void)
{

}
/*-----*/
/* Function Name: HW4_ISR() */
/* Description : PT1 interrupt Service Routine (HW4). */
/* Arguments : None. */
/* Return Value : None. */
/* Remark : */
/*-----*/
void HW4_ISR(void)
{
    uint32_t PORT_IntFlag;

    PORT_IntFlag=DrvGPIO_GetIntFlag(KEY_PORT);
    if((PORT_IntFlag&KEYIN0)==KEYIN0) //PT1.1
```

```
{
    PT1INTSTATUSbits.b_PTINT1done=1;
}
if((PORT_IntFlag&KEYIN1)==KEYIN1)           //PT1.2
{
    PT1INTSTATUSbits.b_PTINT2done=1;
}
DrvGPIO_ClearIntFlag(KEY_PORT,KEYIN1|KEYIN0); //clear PT1_2/PT1_1 interrupt flag
}
/*-----*/
/* Function Name: HW5_ISR()                      */
/* Description   : PT2 interrupt Service Routine (HW5).          */
/* Arguments    : None.                                         */
/* Return Value : None.                                         */
/* Remark      :                                               */
/*-----*/
void HW5_ISR(void)
{

}
/*-----*/
/* Function Name: HW7_ISR()                      */
/* Description   : UART2 interrupt Service Routine (HW7).        */
/* Arguments    : None.                                         */
/* Return Value : None.                                         */
/* Remark      :                                               */
/*-----*/
void HW7_ISR(void)
{

}
/*-----*/
/* Function Name: HW8_ISR()                      */
/* Description   : TMB2 interrupt Service Routine (HW8).        */
/* Arguments    : None.                                         */
/* Return Value : None.                                         */
/* Remark      :                                               */
/*-----*/
```

```
void HW8_ISR(void)
{

}
/*-----*/
/* Function Name: tlb_exception_handler() */
/* Description : Exception Service Routines. */
/* Arguments : None. */
/* Return Value : None. */
/* Remark : */
/*-----*/
void tlb_exception_handler()
{
    asm("nop"); //procedure define by customer.
    asm("nop");
}

/*-----*/
/* Software Delay Subroutines */
/*-----*/
void Delay(unsigned int num)
{
    for(;num>0;num--)
        asm("NOP");
}

/*-----*/
/* End Of File */
/*-----*/
```

10. 類比 IP(8 bit Resistance Ladder DAC)

10.1. 範例名稱

HY16F198B_DAC

10.2. 範例說明

(1) 8 bit Resistance ladder DAC 使用說明

(2) 程式先將 VDDA 做開啟動作，設置 VDDA 為 8 bit Resistance Ladder 的正端，負端設置為 VSS。在此設置下，DAC 能夠輸出的最高電壓為 VDDA

(3) DAC 的輸出由第 0 階開始輸出到 255 階，可以由 IC 腳位 DAO 量到 DAC 輸出電壓

10.3. 軟體流程

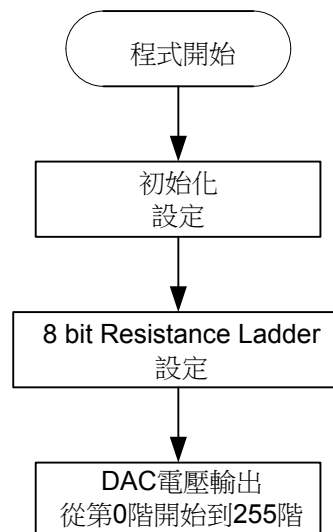

10.4. 程式碼

```
/******  
*  
* Copyright (c) 2016-2026 HYCON Technology, Inc.  
* All rights reserved.  
* HYCON Technology <www.hycontek.com>  
*  
* HYCON reserves the right to amend this code without notice at any time.  
* HYCON assumes no responsibility for any errors appeared in the code,  
* and HYCON disclaims any express or implied warranty, relating to sale  
* and/or use of this code including liability or warranties relating  
* to fitness for a particular purpose, or infringement of any patent,  
* copyright or other intellectual property right.  
*  
* -----  
* Project Name : HY16F198B_DAC  
* IDE tooling : AndeSight C/C++ IDE, version: 2.1.1 Build ID : 201608241332  
* Device Ver. : HY16F_RDSP3_DeviceV0.2 crt0.o for HY16F19xB MCU.  
* Library Ver. : 1.3  
* MCU Device :  
* Description :  
* Created Date : 2018/2/18  
* Created by :  
*  
* Program Description:  
* -----  
*****/  
/*-----*/  
/* Includes */  
/*-----*/  
#include "DrvDAC.h"  
#include "DrvPMU.h"  
#include "DrvREG32.h"  
#include "HY16F198.h"  
#include "System.h"  
#include "my define.h"
```

```
/*-----*/
/* Global CONSTANTS */
/*-----*/

/*-----*/
/* Function PROTOTYPES */
/*-----*/
void Delay(unsigned int num);

/*-----*/
/* MAIN function */
/*-----*/
int main(void)
{
    unsigned char i;

    DrvPMU_VDDA_LDO_Ctrl(E_LDO);           //LDO ON
    DrvPMU_VDDA_Voltage(E_VDDA2_4);      //VDDA=2.4

    DrvDAC_Open(E_DAC_PVDDA,E_DAC_NVSSA,0); //DAC_Vrefp=VDDA, DAC_Vrefn= VSSA, DAO=0
    DrvDAC_SetoutputIO(ENABLE);           //DAC output with PT3.1
    DrvDAC_EnableOutput();                //DAC output enable
    DrvDAC_Enable();                       //DAC IP enable

    while(1)
    {
        for(i=0;i<256;i++)
        {
            DrvDAC_DABIT(i);
            Delay(1000);

            //User can use meter to check the pin49(PT3.1) to pin100(VSS) to check the DAC output voltage
        }
    }
    return 0;
}

/*-----*/
```

HY16F19 系列

HYCON IP 使用說明書

```
/* Function Name: HW0_ISR() */
/* Description : I2C/UART/SPI interrupt Service Routine (HW0). */
/* Arguments : None. */
/* Return Value : None. */
/* Remark : */
/*-----*/
void HW0_ISR(void)
{

}
/*-----*/

/* Function Name: HW1_ISR() */
/* Description : WDT & RTC & Timer A/B/C interrupt Service Routine (HW1). */
/* Arguments : None. */
/* Return Value : None. */
/* Remark : */
/*-----*/
void HW1_ISR(void)
{

}
/*-----*/

/* Function Name: HW2_ISR() */
/* Description : ADC interrupt Service Routine (HW2). */
/* Arguments : None. */
/* Return Value : None. */
/* Remark : */
/*-----*/
void HW2_ISR(void)
{

}
/*-----*/

/* Function Name: HW3_ISR() */
/* Description : CMP & OPA interrupt Service Routine (HW3). */
/* Arguments : None. */
/* Return Value : None. */
/* Remark : */
```

```
/*-----*/
void HW3_ISR(void)
{

}
/*-----*/
/* Function Name: HW4_ISR() */
/* Description : PT1 interrupt Service Routine (HW4). */
/* Arguments : None. */
/* Return Value : None. */
/* Remark : */
/*-----*/
void HW4_ISR(void)
{

}
/*-----*/
/* Function Name: HW5_ISR() */
/* Description : PT2 interrupt Service Routine (HW5). */
/* Arguments : None. */
/* Return Value : None. */
/* Remark : */
/*-----*/
void HW5_ISR(void)
{

}
/*-----*/
/* Function Name: HW7_ISR() */
/* Description : UART2 interrupt Service Routine (HW7). */
/* Arguments : None. */
/* Return Value : None. */
/* Remark : */
/*-----*/
void HW7_ISR(void)
{

}
```

HY16F19 系列

HYCON IP 使用說明書

```
/*-----*/
/* Function Name: HW8_ISR() */
/* Description : TMB2 interrupt Service Routine (HW8). */
/* Arguments : None. */
/* Return Value : None. */
/* Remark : */
/*-----*/
void HW8_ISR(void)
{

}
/*-----*/
/* Function Name: tlb_exception_handler() */
/* Description : Exception Service Routines. */
/* Arguments : None. */
/* Return Value : None. */
/* Remark : */
/*-----*/
void tlb_exception_handler()
{
    asm("nop"); //procedure define by customer.
    asm("nop");
}
/*-----*/
/* Software Delay Subroutines */
/*-----*/
void Delay(unsigned int num)
{
    for(;num>0;num--)
        asm("NOP");
}

/*-----*/
/* End Of File */
/*-----*/
```

11. 類比 IP(OPA)

11.1. 範例名稱

HY16F198B_OPA

11.2. 範例說明

- (1) OPAMP 使用與設定方式
- (2) 將類比電壓 REFO=1.2V 打開
- (3) 程式選擇 REFO 為 OPAMP 的正端, OPAMP 的負端選擇 AIO5.
- (4) 將 OPAMP 當作比較器使用, 當 REFO 電壓大於 AIO5, OPO 腳位 PT3.7 會輸出 High, 當 REFO 電壓小於 AIO5, OPO 腳位 PT3.7 會輸出 Low.
- (5) 每當 OPAMP 進入中斷一次, PT2.0 腳位會產生 High or Low 的狀態變化

11.3. 軟體流程

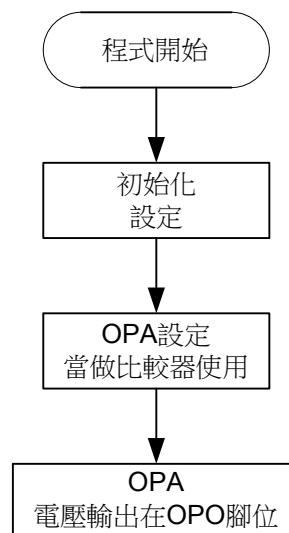

11.4. 程式碼

```
/******  
*  
* Copyright (c) 2016-2026 HYCON Technology, Inc.  
* All rights reserved.  
* HYCON Technology <www.hycontek.com>  
*  
* HYCON reserves the right to amend this code without notice at any time.  
* HYCON assumes no responsibility for any errors appeared in the code,  
* and HYCON disclaims any express or implied warranty, relating to sale  
* and/or use of this code including liability or warranties relating  
* to fitness for a particular purpose, or infringement of any patent,  
* copyright or other intellectual property right.  
*  
* -----  
* Project Name : HY16F198B_OPA  
* IDE tooling : AndeSight C/C++ IDE, version: 2.1.1 Build ID : 201608241332  
* Device Ver. : HY16F_RDSP3_DeviceV0.2 crt0.o for HY16F19xB MCU.  
* Library Ver. : 1.3  
* MCU Device :  
* Description :  
* Created Date : 2018/2/18  
* Created by :  
*  
* Program Description:  
* -----  
*****/  
/*-----*/  
/* Includes */  
/*-----*/  
#include "DrvGPIO.h"  
#include "DrvOP.h"  
#include "DrvPMU.h"  
#include "DrvREG32.h"  
#include "HY16F198.h"  
#include "System.h"  
#include "my define.h"
```

```
/*-----*/
/* STRUCTURES */
/*-----*/
volatile typedef union _MCUSTATUS
{
    char _byte;
    struct
    {
        unsigned b_ADCdone:1;
        unsigned b_TMAdone:1;
        unsigned b_TMBdone:1;
        unsigned b_TMC0done:1;
        unsigned b_TMC1done:1;
        unsigned b_UART_TxDone:1;
        unsigned b_UART_RxDone:1;
        unsigned b_OPAdone:1;
    };
} MCUSTATUS;

/*-----*/
/* DEFINITIONS */
/*-----*/
#define KEY_PORT E_PT2
#define KEYIN0 BIT0
/*-----*/
/* Global CONSTANTS */
/*-----*/
MCUSTATUS MCUSTATUSbits;
unsigned char i;
/*-----*/
/* Function PROTOTYPES */
/*-----*/
void Delay(unsigned int num);

/*-----*/
/* MAIN function */
/*-----*/
int main(void)
```



```
{

i=0;

DrvPMU_VDDA_LDO_Ctrl(E_LDO);           //LDO ON
DrvPMU_VDDA_Voltage(E_VDDA2_4);       //VDDA=2.4
DrvPMU_REFO_Enable();                 //REFO ON

DrvGPIO_Open(E_PT2,KEYIN0,E_IO_OUTPUT); //PT2.0 Output

DrvOP_Open();
DrvOP_PInput(0x08);                   //OPA positive reference input selection REFO
DrvOP_NInput(0x02);                   //OPA negative reference input selection AIO5
DrvOP_OPOutEnable();                  //OPA Out Enable PT3.7. If REFO>AIO5, PT3.7=High, IF REFO<AIO5,
PT3.7=Low
DrvOP_OPDEN(1);                       //OPDEN=1b

DrvOP_EnableInt();
MCUSTATUSbits._byte = 0;
SYS_EnableGIE(4,0x1FF);               //Enable GIE(Global Interrupt)

while(1)
{
    //If REFO>AIO5, enter HW3_ISR()
}

return 0;
}

/*-----*/
/* Function Name: HW0_ISR                                */
/* Description   : I2C/UART/SPI interrupt Service Routine (HW0). */
/* Arguments    : None.                                     */
/* Return Value : None.                                     */
/* Remark      :                                           */
/*-----*/

void HW0_ISR(void)
```

```
{

}

/*-----*/
/* Function Name: HW1_ISR() */
/* Description : WDT & RTC & Timer A/B/C interrupt Service Routine (HW1). */
/* Arguments : None. */
/* Return Value : None. */
/* Remark : */
/*-----*/
void HW1_ISR(void)
{

}
/*-----*/
/* Function Name: HW2_ISR() */
/* Description : ADC interrupt Service Routine (HW2). */
/* Arguments : None. */
/* Return Value : None. */
/* Remark : */
/*-----*/
void HW2_ISR(void)
{

}
/*-----*/
/* Function Name: HW3_ISR() */
/* Description : CMP & OPA interrupt Service Routine (HW3). */
/* Arguments : None. */
/* Return Value : None. */
/* Remark : */
/*-----*/
void HW3_ISR(void)
{
    if(DrvOP_ReadIntFlag())
    {
        if(i==ENABLE)
        {
```

```
    DrvGPIO_ClrPortBits(E_PT2,KEYIN0); //PT2.0 Output Low
    i=DISABLE;
}
else
{
    DrvGPIO_SetPortBits(E_PT2,KEYIN0); //PT2.0 Output High
    i=ENABLE;
}
DrvOP_ClearIntFlag(); //Clear OPA interrupt flag
}
}

/*-----*/
/* Function Name: HW4_ISR() */
/* Description : PT1 interrupt Service Routine (HW4). */
/* Arguments : None. */
/* Return Value : None. */
/* Remark : */
/*-----*/
void HW4_ISR(void)
{

}
/*-----*/
/* Function Name: HW5_ISR() */
/* Description : PT2 interrupt Service Routine (HW5). */
/* Arguments : None. */
/* Return Value : None. */
/* Remark : */
/*-----*/
void HW5_ISR(void)
{

}
/*-----*/
/* Function Name: HW7_ISR() */
/* Description : UART2 interrupt Service Routine (HW7). */
/* Arguments : None. */
```

```
/* Return Value : None. */
/* Remark      : */
/*-----*/
void HW7_ISR(void)
{

}
/*-----*/
/* Function Name: HW8_ISR() */
/* Description  : TMB2 interrupt Service Routine (HW8). */
/* Arguments   : None. */
/* Return Value : None. */
/* Remark      : */
/*-----*/
void HW8_ISR(void)
{

}
/*-----*/
/* Function Name: tlb_exception_handler() */
/* Description  : Exception Service Routines. */
/* Arguments   : None. */
/* Return Value : None. */
/* Remark      : */
/*-----*/
void tlb_exception_handler()
{
    asm("nop"); //procedure define by customer.
    asm("nop");
}
/*-----*/
/* Software Delay Subroutines */
/*-----*/
void Delay(unsigned int num)
{
    for(;num>0;num--)
        asm("NOP");
}
```

HY16F19 系列 HYCON IP 使用說明書



}

/*-----*/

/* End Of File

*/

/*-----*/

12. 類比 IP(ADC)

12.1. 範例名稱

HY16F198B_ADC

12.2. 範例說明

- (1)透過 ADC 相關設定, 可以實現 ADC 進入中斷抓取 ADC 輸出暫存器資料.
- (2)ADC 初始設置包含, 設置 ADC 的類比電源為 VDDA, 設置 ADC 的取樣頻率 OSR 為 32768, ADC 資料的輸出頻率為 10Hz(sps), 設置 ADC 的輸入端設置為 AIO0-AIO1, 設置 ADC 的參考電壓設置為 VDDA 對 VSS.
- (3) ADC 初始設置完成後, 開啟 System GIE 等待 ADC 中斷發生. ADC OSR 設置可決定 ADC 進入中斷的速度. 進入 ADC 中斷抓取的 ADC 輸出暫存器資料顯示在 LCD 上.

12.3. 軟體流程

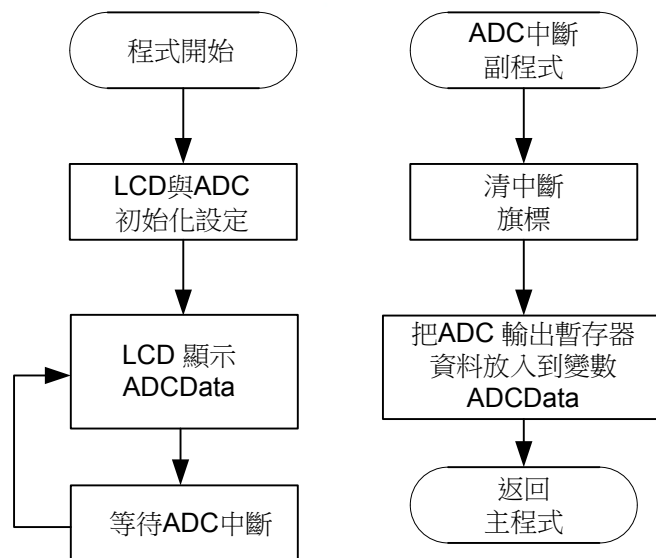

12.4. 程式碼

```
/******  
*  
* Copyright (c) 2016-2026 HYCON Technology, Inc.  
* All rights reserved.  
* HYCON Technology <www.hycontek.com>  
*  
* HYCON reserves the right to amend this code without notice at any time.  
* HYCON assumes no responsibility for any errors appeared in the code,  
* and HYCON disclaims any express or implied warranty, relating to sale  
* and/or use of this code including liability or warranties relating  
* to fitness for a particular purpose, or infringement of any patent,  
* copyright or other intellectual property right.  
*  
* -----  
* Project Name : HY16F198B_ADC  
* IDE tooling : AndeSight C/C++ IDE, version: 2.1.1 Build ID : 201608241332  
* Device Ver. : HY16F_RDSp3_DeviceV0.2 crt0.o for HY16F19xB MCU.  
* Library Ver. : 1.3  
* MCU Device :  
* Description :  
* Created Date : 2018/2/18  
* Created by :  
*  
* Program Description:  
* -----  
*****/  
/*-----*/  
/* Includes */  
/*-----*/  
#include "HY16F198.h"  
#include "DrvADC.h"  
#include "DrvLCD.h"  
#include "DrvPMU.h"  
#include "System.h"  
#include "Display.h"
```

```
#include "my define.h"
#include "DrvREG32.h"
#include "DrvClock.h"
/*-----*/
/* STRUCTURES */
/*-----*/
volatile typedef union _MCUSTATUS
{
    char _byte;
    struct
    {
        unsigned b_ADCdone:1;
        unsigned b_TMAdone:1;
        unsigned b_TMBdone:1;
        unsigned b_TMC0done:1;
        unsigned b_TMC1done:1;
        unsigned b_RTCdone:1;
        unsigned b_UART_TxDone:1;
        unsigned b_UART_RxDone:1;
    };
} MCUSTATUS;

/*-----*/
/* DEFINITIONS */
/*-----*/
#define HAO_2MHZ
//#define HAO_4MHZ
//#define HAO_10MHZ
//#define HAO_16MHZ

/*-----*/
/* Global CONSTANTS */
/*-----*/
MCUSTATUS MCUSTATUSbits;
int ADCData;

/*-----*/
/* Function PROTOTYPES */
*/
```

HY16F19 系列

HYCON IP 使用說明書

```
/*-----*/
void InitalADC(void);
void Delay(unsigned int num);

/*-----*/
/* MAIN function */
/*-----*/
int main(void)
{

    InitalADC();
    DisplayInit();
    ClearLCDframe();
    Delay(10000);
    DisplayHYcon();
    Delay(10000);
    SYS_EnableGIE(4,0x1FF);           //Enable GIE(Global Interrupt)

    MCUSTATUSbits._byte = 0;

    while(1)
    {
        if(MCUSTATUSbits.b_ADCdone)
        {
            LCD_DATA_DISPLAY(ADCData>>16);           //16bits give up.
            MCUSTATUSbits.b_ADCdone=0;
        }
    }
    return 0;
}

/*-----*/
/* Function Name: HW0_ISR() */
/* Description : I2C/UART/SPI interrupt Service Routine (HW0). */
/* Arguments : None. */
/* Return Value : None. */
/* Remark : */
/*-----*/
```

```
void HW0_ISR(void)
{

}
/*-----*/
/* Function Name: HW1_ISR() */
/* Description : WDT & RTC & Timer A/B/C interrupt Service Routine (HW1). */
/* Arguments : None. */
/* Return Value : None. */
/* Remark : */
/*-----*/
void HW1_ISR(void)
{

}
/*-----*/
/* Function Name: HW2_ISR() */
/* Description : ADC interrupt Service Routine (HW2). */
/* Arguments : None. */
/* Return Value : None. */
/* Remark : */
/*-----*/
void HW2_ISR(void)
{
    if(DrvADC_ReadIntFlag())
    {
        DrvADC_ClearIntFlag();
        ADCData=DrvADC_GetConversionData();
        MCUSTATUSbits.b_ADCdone=1;
    }
}
/*-----*/
/* Function Name: HW3_ISR() */
/* Description : CMP & OPA interrupt Service Routine (HW3). */
/* Arguments : None. */
/* Return Value : None. */
/* Remark : */
/*-----*/
```

```
void HW3_ISR(void)
{

}
/*-----*/
/* Function Name: HW4_ISR() */
/* Description : PT1 interrupt Service Routine (HW4). */
/* Arguments : None. */
/* Return Value : None. */
/* Remark : */
/*-----*/
void HW4_ISR(void)
{

}
/*-----*/
/* Function Name: HW5_ISR() */
/* Description : PT2 interrupt Service Routine (HW5). */
/* Arguments : None. */
/* Return Value : None. */
/* Remark : */
/*-----*/
void HW5_ISR(void)
{

}
/*-----*/
/* Function Name: HW7_ISR() */
/* Description : UART2 interrupt Service Routine (HW7). */
/* Arguments : None. */
/* Return Value : None. */
/* Remark : */
/*-----*/
void HW7_ISR(void)
{

}
/*-----*/
```

```
/* Function Name: HW8_ISR() */
/* Description : TMB2 interrupt Service Routine (HW8). */
/* Arguments : None. */
/* Return Value : None. */
/* Remark : */
/*-----*/
void HW8_ISR(void)
{

}
/*-----*/

/* Function Name: tlb_exception_handler() */
/* Description : Exception Service Routines. */
/* Arguments : None. */
/* Return Value : None. */
/* Remark : */
/*-----*/
void tlb_exception_handler()
{
    asm("nop"); //procedure define by customer.
    asm("nop");
}
/*-----*/

/* Function Name: InitalADC() */
/* Description : ADC Initialization Subroutines. */
/* Arguments : None. */
/* Return Value : None. */
/* Remark : */
/*-----*/
void InitalADC(void)
{

#ifdef HAO_2MHZ
    DrvCLOCK_EnableHighOSC(E_INTERNAL,10); //Select HSRC
    DrvCLOCK_SelectIHOSC(0); //Select internal 2MHZ
    DrvADC_ClkEnable(0,1); //Setting ADC CLOCK ADCK=HS_CK/6 & Rising edge is high
#endif

#ifdef HAO_4MHZ
```

```
DrvCLOCK_EnableHighOSC(E_INTERNAL,10); //Select HSRC
DrvCLOCK_SelectIHOSC(1); //Select internal 4MHZ
DrvADC_ClkEnable(1,1); //Setting ADC CLOCK ADCK=HS_CK/12 & Rising edge is high
#endif
#if defined(HAO_10MHZ)
DrvCLOCK_EnableHighOSC(E_INTERNAL,10); //Select HSRC
DrvCLOCK_SelectIHOSC(2); //Select internal 10MHZ
DrvADC_ClkEnable(2,1); //Setting ADC CLOCK ADCK=HS_CK/30 & Rising edge is high
#endif
#if defined(HAO_16MHZ)
DrvCLOCK_EnableHighOSC(E_INTERNAL,10); //Select HSRC
DrvCLOCK_SelectIHOSC(3); //Select internal 16MHZ
DrvADC_ClkEnable(3,1); //Setting ADC CLOCK ADCK=HS_CK/60 & Rising edge is high
#endif

//Set VDDA voltage
DrvPMU_VDDA_LDO_Ctrl(E_LDO);
DrvPMU_VDDA_Voltage(E_VDDA2_4);
DrvPMU_BandgapEnable();

Delay(0x1000);
DrvPMU_AnalogGround(ENABLE); //ADC analog ground source selection.
//1 : Enable buffer and use internal source(need to work with ADC)

//Set ADC input pin
DrvADC_SetADCInputChannel(ADC_Input_AIO0,ADC_Input_AIO1); //Set the ADC positive/negative input voltage source.
DrvADC_InputSwitch(OPEN); //ADC signal input (positive and negative) short(VISHR) control.
DrvADC_RefInputShort(OPEN); //Set the ADC reference input (positive and negative) short(VRSHR) control.

DrvADC_Gain(ADC_PGA_Disable,ADC_PGA_Disable); //Input signal gain for modulator.
DrvADC_DCOffset(0); //DC offset input voltage selection (VREF=REFP-REFN)
DrvADC_RefVoltage(0,0); //Set the ADC reference voltage. VDDA-VSSA
DrvADC_FullRefRange(1); //Set the ADC full reference range select.
//0: Full reference range input
//1: 1/2 reference range input

DrvADC_OSR(0); //0 : OSR=32768

//Set ADC interrupt
```

```
DrvADC_ClearIntFlag();
DrvADC_EnableInt();
DrvADC_Enable();
DrvADC_CombFilter(ENABLE);          //Enable comb filter
}
/*-----*/
/* Software Delay Subroutines      */
/*-----*/
void Delay(unsigned int num)
{
    for(;num>0;num--)
        asm("NOP");
}

/*-----*/
/* End Of File                      */
/*-----*/
```

13. 類比 IP(LCD)

13.1. 範例名稱

HY16F198B_LCD

13.2. 範例說明

- (1)LCD 使用方式說明
- (2)開啟 LCD 並設定 VLCD 電壓及 Duty
- (3)將部分 I/O 設定為 LCD Mode
- (4)於 LCD 面板上顯示 HYCON 字樣
- (5)HYCON 顯示後,會開始由 0 慢慢往上數, 數至 50000

13.3. 軟體流程

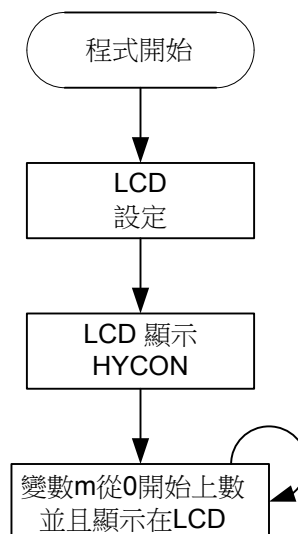

13.4. 程式碼

```
/******  
*  
* Copyright (c) 2016-2026 HYCON Technology, Inc.  
* All rights reserved.  
* HYCON Technology <www.hycontek.com>  
*  
* HYCON reserves the right to amend this code without notice at any time.  
* HYCON assumes no responsibility for any errors appeared in the code,  
* and HYCON disclaims any express or implied warranty, relating to sale  
* and/or use of this code including liability or warranties relating  
* to fitness for a particular purpose, or infringement of any patent,  
* copyright or other intellectual property right.  
*  
* -----  
* Project Name : HY16F198B_LCD  
* IDE tooling : AndeSight C/C++ IDE, version: 2.1.1 Build ID : 201608241332  
* Device Ver. : HY16F_RDSp3_DeviceV0.2 crt0.o for HY16F19xB MCU.  
* Library Ver. : 1.3  
* MCU Device :  
* Description :  
* Created Date : 2018/2/18  
* Created by :  
*  
* Program Description:  
* -----  
*****/  
/*-----*/  
/* Includes */  
/*-----*/  
#include "HY16F198.h"  
#include "DrvLCD.h"  
#include "Display.h"  
#include "my define.h"  
  
/*-----*/
```



```
/* STRUCTURES                                                                 */
/*-----*/
volatile typedef union _MCUSTATUS
{
    char _byte;
    struct
    {
        unsigned b_ADCdone:1;
        unsigned b_TMAdone:1;
        unsigned b_TMBdone:1;
        unsigned b_TMCdone:1;
        unsigned b_RTCdone:1;
        unsigned b_UART_TxDone:1;
        unsigned b_UART_RxDone:1;
        unsigned b_UartConn:1;
    };
} MCUSTATUS;

/*-----*/
/* DEFINITIONS                                                                 */
/*-----*/
#define LCDTEST
#define LOOPTEST

/*-----*/
/* Global CONSTANTS                                                            */
/*-----*/
MCUSTATUS  MCUSTATUSbits;

/*-----*/
/* Function PROTOTYPES                                                         */
/*-----*/
void Delay(unsigned int num);

/*-----*/
/* MAIN function                                                                */
/*-----*/
int main(void)
```

```
{
    DisplayInit();
    ClearLCDframe();

    DisplayHYcon();
    Delay(500000);

#if defined(LCDTEST)
    DisplayTest();
    LCD_DATA_DISPLAY(-123456);
    DisplayPASS(1);
#endif

#if defined(LOOPTEST)
    unsigned int m;
    for(m=0;m<50000;m++)
    {
        LCD_DATA_DISPLAY(m);
        Delay(65535);
    }
#endif

    while(1);
    return 0;
}
/*-----*/
/* Function Name: HW0_ISR() */
/* Description : I2C/UART/SPI interrupt Service Routine (HW0). */
/* Arguments : None. */
/* Return Value : None. */
/* Remark : */
/*-----*/
void HW0_ISR(void)
{

}
/*-----*/
/* Function Name: HW1_ISR() */
```

HY16F19 系列

HYCON IP 使用說明書

```
/* Description   : WDT & RTC & Timer A/B/C interrupt Service Routine (HW1).   */
/* Arguments    : None.                                                       */
/* Return Value : None.                                                       */
/* Remark      :                                                               */
/*-----*/
void HW1_ISR(void)
{

}
/*-----*/
/* Function Name: HW2_ISR()                                                  */
/* Description   : ADC interrupt Service Routine (HW2).                       */
/* Arguments    : None.                                                       */
/* Return Value : None.                                                       */
/* Remark      :                                                               */
/*-----*/
void HW2_ISR(void)
{

}
/*-----*/
/* Function Name: HW3_ISR()                                                  */
/* Description   : CMP & OPA interrupt Service Routine (HW3).                */
/* Arguments    : None.                                                       */
/* Return Value : None.                                                       */
/* Remark      :                                                               */
/*-----*/
void HW3_ISR(void)
{

}
/*-----*/
/* Function Name: HW4_ISR()                                                  */
/* Description   : PT1 interrupt Service Routine (HW4).                       */
/* Arguments    : None.                                                       */
/* Return Value : None.                                                       */
/* Remark      :                                                               */
/*-----*/
```

```
void HW4_ISR(void)
{

}
/*-----*/
/* Function Name: HW5_ISR() */
/* Description : PT2 interrupt Service Routine (HW5). */
/* Arguments : None. */
/* Return Value : None. */
/* Remark : */
/*-----*/
void HW5_ISR(void)
{

}
/*-----*/
/* Function Name: HW7_ISR() */
/* Description : UART2 interrupt Service Routine (HW7). */
/* Arguments : None. */
/* Return Value : None. */
/* Remark : */
/*-----*/
void HW7_ISR(void)
{

}
/*-----*/
/* Function Name: HW8_ISR() */
/* Description : TMB2 interrupt Service Routine (HW8). */
/* Arguments : None. */
/* Return Value : None. */
/* Remark : */
/*-----*/
void HW8_ISR(void)
{

}
/*-----*/
```

HY16F19 系列

HYCON IP 使用說明書

```
/* Function Name: tlb_exception_handler() */
/* Description : Exception Service Routines. */
/* Arguments : None. */
/* Return Value : None. */
/* Remark : */
/*-----*/
void tlb_exception_handler()
{
    asm("nop"); //procedure define by customer.
    asm("nop");
}
/*-----*/
/* Software Delay Subroutines */
/*-----*/
void Delay(unsigned int num)
{
    for(;num>0;num--)
        asm("NOP");
}
/*-----*/
/* End Of File */
/*-----*/
```

14. 類比 IP(CMP)

14.1. 範例名稱

HY16F198B_CMP

14.2. 範例說明

(1)CMP 使用方式說明

(2)利用程式碼#define 來選擇要編譯執行 V12_Voltage_mueasure 或 RLO_Voltage_mueasure 或 CH3_Compare_CH2_Voltage.

(3)如果選擇執行編譯 V12_Voltage_mueasure, 則可以從 HY16F 的 CH1(PT1.0)-VSS 腳位量到內部 V12(REFO)電壓輸出.

(4)如果選擇執行編譯 RLO_Voltage_mueasure, 則可以從 HY16F 的 CH1(PT1.0)-VSS 腳位量到 VDD3V 透過內部 16 段分壓電組產生的電壓輸出.

(5)如果選擇執行編譯 CH3_Compare_CH2_Voltage. 比較 CH3(PT1.2)與 CH2(PT1.1)的電壓大小, 當 CH3(PT1.2)大於 CH2(PT1.1), 則 LCD 會顯示” 1” 同時 CMPO 腳位為 High, 當 CH2(PT1.1)大於 CH3(PT1.2), 則 LCD 會顯示” 0” 同時 CMPO 腳位為 Low

14.3. 程式碼

```
/******
```

```
*
```

```
* Copyright (c) 2016-2026 HYCON Technology, Inc.
```

```
* All rights reserved.
```

```
* HYCON Technology <www.hycontek.com>
```

```
*
```

```
* HYCON reserves the right to amend this code without notice at any time.
```

```
* HYCON assumes no responsibility for any errors appeared in the code,
```

```
* and HYCON disclaims any express or implied warranty, relating to sale
```

```
* and/or use of this code including liability or warranties relating
```

```
* to fitness for a particular purpose, or infringement of any patent,
```

```
* copyright or other intellectual property right.
```

```
*
```

```
* -----
```

```
* Project Name : HY16F198B_CMP
```

```
* IDE tooling : AndeSight C/C++ IDE, version: 2.1.1 Build ID : 201608241332
```

```
* Device Ver. : HY16F_RDSp3_DeviceV0.2 crt0.o for HY16F19xB MCU.
```

* Library Ver. : 1.3
* MCU Device :
* Description :
* Created Date : 2017/2/18
* Created by :

*
* Program Description:

* -----
*****/

/*-----*/

/* Includes */

/*-----*/

#include "DrvCMP.h"

#include "DrvGPIO.h"

#include "DrvLCD.h"

#include "DrvREG32.h"

#include "HY16F198.h"

#include "System.h"

#include "my define.h"

#include "Display.h"

#include "DrvPMU.h"

/*-----*/

/* STRUCTURES */

/*-----*/

volatile typedef union _MCUSTATUS

{

char _byte;

struct

{

unsigned b_ADCdone:1;

unsigned b_TMAdone:1;

unsigned b_TMBdone:1;

unsigned b_TMC0done:1;

unsigned b_TMC1done:1;

unsigned b_CMPdone:1;

unsigned b_UART_TxDone:1;

unsigned b_UART_RxDone:1;

};

```
} MCUSTATUS;

/*-----*/
/* DEFINITIONS */
/*-----*/
#define CMPO_PORT E_PT1
#define CMPOut BIT7

//#define V12_Voltage_mueasure
//#define RLO_Voltage_mueasure
#define CH3_Compare_CH2_Voltage

/*-----*/
/* Global CONSTANTS */
/*-----*/
MCUSTATUS  MCUSTATUSbits;

/*-----*/
/* Function PROTOTYPES */
/*-----*/
void Delay(unsigned int num);

/*-----*/
/* MAIN  function */
/*-----*/
int main(void)
{

    //Display Setting
    DisplayInit();
    ClearLCDframe();
    DisplayHYcon();

    //GPIO Setting & GPIO Setting
    DrvGPIO_Open(CMPO_PORT,CMPOut,E_IO_OUTPUT); //Set PT1_7 OUTPUT

    #if defined(RLO_Voltage_mueasure)
        DrvCMP_PInput(E_CH1); //CMP positive input CH1
    #endif
}
```



```
DrvCMP_NInput(E_RLO);           //CMP negative input RLO
DrvCMP_RLO_refV(2,1);           //RLO=VDD3V, CPIS=Closed
DrvCMP_InputSwitch(1);          //INPUT SHORT SWITCH ENABLE
#endif

#if defined(V12_Voltage_mueasure)
  DrvPMU_VDDA_Voltage(E_VDDA2_4);
  DrvPMU_VDDA_LDO_Ctrl(E_LDO);
  DrvPMU_BandgapEnable();
  DrvPMU_REFO_Enable();
  DrvCMP_PInput(E_V12);          //CMP positive input V12
  DrvCMP_NInput(E_CH1);          //CMP negative input CH1
  DrvCMP_InputSwitch(1);          //INPUT SHORT SWITCH ENABLE
#endif

#if defined(CH3_Compare_CH2_Voltage)
  unsigned int i=0;
  DrvCMP_PInput(E_CH3);           //CMP positive input CH3
  DrvCMP_NInput(E_CH2);           //CMP negative input CH2
  DrvCMP_InputSwitch(0);          //INPUT SHORT SWITCH ENABLE
#endif

DrvCMP_Enable();                 //CMP enable.
DrvCMP_OutputPinEnable(0);        //Enable CMP digital output to port
                                   //0 : PT1.7

#if defined(RLO_Voltage_mueasure)
  // Setting CPDM=0000b and CPDA to observe RLO voltage
  DrvCMP_RLO_Ctrl(0x00,0x00);      //CH1 to VSS around 0.0062V
  DrvCMP_RLO_Ctrl(0x01,0x00);      //CH1 to VSS around 0.2132V
  DrvCMP_RLO_Ctrl(0x02,0x00);      //CH1 to VSS around 0.4163V
  DrvCMP_RLO_Ctrl(0x03,0x00);      //CH1 to VSS around 0.6205V
  DrvCMP_RLO_Ctrl(0x04,0x00);      //CH1 to VSS around 0.8221V
  DrvCMP_RLO_Ctrl(0x05,0x00);      //CH1 to VSS around 1.0252V
  DrvCMP_RLO_Ctrl(0x06,0x00);      //CH1 to VSS around 1.2290V
  DrvCMP_RLO_Ctrl(0x07,0x00);      //CH1 to VSS around 1.4355V
  DrvCMP_RLO_Ctrl(0x08,0x00);      //CH1 to VSS around 1.6393V
  DrvCMP_RLO_Ctrl(0x09,0x00);      //CH1 to VSS around 1.8449V
```

```
DrvCMP_RLO_Ctrl(0x0A,0x00); //CH1 to VSS around 2.0476V
DrvCMP_RLO_Ctrl(0x0B,0x00); //CH1 to VSS around 2.2535V
DrvCMP_RLO_Ctrl(0x0C,0x00); //CH1 to VSS around 2.4577V
DrvCMP_RLO_Ctrl(0x0D,0x00); //CH1 to VSS around 2.6613V
DrvCMP_RLO_Ctrl(0x0E,0x00); //CH1 to VSS around 2.8686V
DrvCMP_RLO_Ctrl(0x0F,0x00); //CH1 to VSS around 3.0777V, VDD3V around 3.3091V

#endif

#if defined(CH3_Compare_CH2_Voltage)
    while(1)
    {
        i=DrvCMP_ReadData();
        LCD_DATA_DISPLAY(i); //IF positive(CH3) > negative(CH2), CMPO=High, LCD Display(1). otherwise CMPO=Low, LCD
Display(0).
    }
#endif

    while(1);
    return 0;
}

/*-----*/
/* Function Name: HW0_ISR() */
/* Description : I2C/UART/SPI interrupt Service Routine (HW0). */
/* Arguments : None. */
/* Return Value : None. */
/* Remark : */
/*-----*/
void HW0_ISR(void)
{

}

/*-----*/
/* Function Name: HW1_ISR() */
/* Description : WDT & RTC & Timer A/B/C interrupt Service Routine (HW1). */
/* Arguments : None. */
/* Return Value : None. */
/* Remark : */
```

```
/*-----*/
void HW1_ISR(void)
{

}
/*-----*/
/* Function Name: HW2_ISR() */
/* Description : ADC interrupt Service Routine (HW2). */
/* Arguments : None. */
/* Return Value : None. */
/* Remark : */
/*-----*/
void HW2_ISR(void)
{

}
/*-----*/
/* Function Name: HW3_ISR() */
/* Description : CMP & OPA interrupt Service Routine (HW3). */
/* Arguments : None. */
/* Return Value : None. */
/* Remark : */
/*-----*/
void HW3_ISR(void)
{
    MCUSTATUSbits.b_CMPdone=1;
    DrvCMP_ClearIntFlag(); //Clear CMP interrupt flag
}
/*-----*/
/* Function Name: HW4_ISR() */
/* Description : PT1 interrupt Service Routine (HW4). */
/* Arguments : None. */
/* Return Value : None. */
/* Remark : */
/*-----*/
void HW4_ISR(void)
{
```

```
}
/*-----*/
/* Function Name: HW5_ISR() */
/* Description : PT2 interrupt Service Routine (HW5). */
/* Arguments : None. */
/* Return Value : None. */
/* Remark : */
/*-----*/
void HW5_ISR(void)
{

}
/*-----*/
/* Function Name: HW7_ISR() */
/* Description : UART2 interrupt Service Routine (HW7). */
/* Arguments : None. */
/* Return Value : None. */
/* Remark : */
/*-----*/
void HW7_ISR(void)
{

}
/*-----*/
/* Function Name: HW8_ISR() */
/* Description : TMB2 interrupt Service Routine (HW8). */
/* Arguments : None. */
/* Return Value : None. */
/* Remark : */
/*-----*/
void HW8_ISR(void)
{

}
/*-----*/
/* Function Name: tlb_exception_handler() */
/* Description : Exception Service Routines. */
/* Arguments : None. */
```

HY16F19 系列

HYCON IP 使用說明書

```
/* Return Value : None. */
/* Remark      : */
/*-----*/
void tlb_exception_handler()
{
    asm("nop");          //procedure define by customer.
    asm("nop");
}
/*-----*/
/* Software Delay Subroutines */
/*-----*/
void Delay(unsigned int num)
{
    for(;num>0;num--)
        asm("NOP");
}

/*-----*/
/* End Of File */
/*-----*/
```

15. 通訊 IP(SPI)

15.1. 範例名稱

HY16F198B_SPI

15.2. 範例說明

- (1) HY16F198B 工作在三線式 SPI Master 來對 SPI Flash 25X40(Winbond)做寫入與讀取控制範例。因為 SPI Master 為三線式，所以 CS(Chip Select)需要使用 GPIO 來做控制，設定 PT2.0=CS 功能。在完成 SPI 所有控制腳位的初始化之後，即可開始進行 SPI 控制動作
- (2) 程式第一段測試為，SPI Flash Manufacturer and Device Identification 讀取確認，如果正確，變數 Flash_ID 會等於 0xEF12
- (3) 程式第二段測試為，矩陣字串 String1 寫入與讀取驗證測試，如果寫入與讀取內容相同，LCD 會顯示 0，如果不相同，LCD 會顯示 1
- (3) 程式第三段測試為，矩陣字串 String2 寫入與讀取驗證測試，如果寫入與讀取內容相同，LCD 會顯示 0，如果不相同，LCD 會顯示 123

15.3. 系統設定

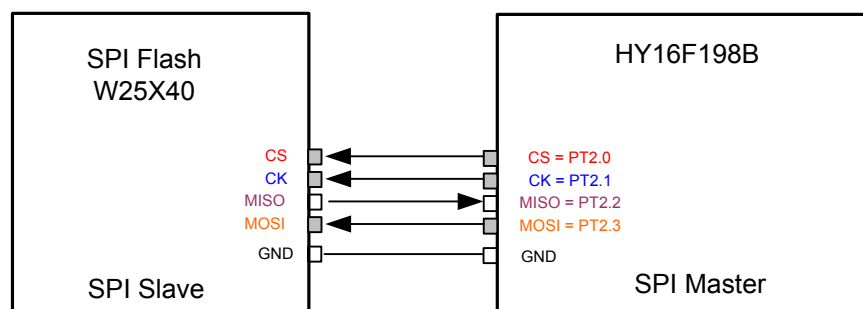

15.4. 軟體流程

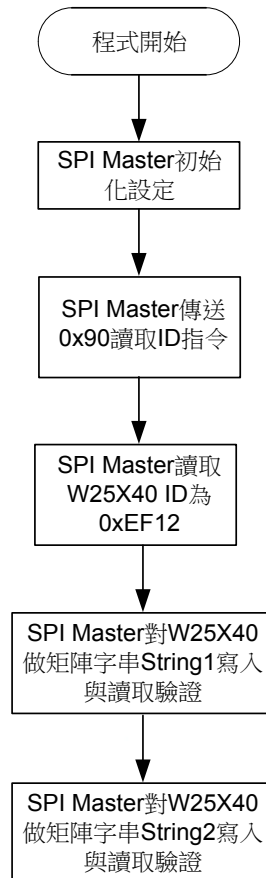

15.5. 程式碼

說明：在此僅貼上 main.c 程式內容做參考。

```
/*  
*  
* Copyright (c) 2016-2026 HYCON Technology, Inc.  
* All rights reserved.  
* HYCON Technology <www.hycontek.com>  
*  
* HYCON reserves the right to amend this code without notice at any time.  
* HYCON assumes no responsibility for any errors appeared in the code,  
* and HYCON disclaims any express or implied warranty, relating to sale  
* and/or use of this code including liability or warranties relating  
* to fitness for a particular purpose, or infringement of any patent,  
* copyright or other intellectual property right.  
*  
* -----  
* Project Name : HY16F198B_SPI  
* IDE tooling : AndeSight C/C++ IDE, version: 2.1.1 Build ID : 201608241332  
* Device Ver. : HY16F_RDSp3_DeviceV0.2 crt0.o for HY16F19xB MCU.  
* Library Ver. : 1.3  
* MCU Device :  
* Description :  
* Created Date : 2018/2/18  
* Created by :  
*  
* Program Description:  
* -----  
*  
* HY16H198          W25Q16BV  
* -----          -----  
*          |          |          |  
* SPI_SS  |<----->| CS  |  
* SPI_CLK |<----->| CLK |  
* SPI_MISO|<----->| DO  |  
* SPI_MOSI|<----->| DI  |  
*          |          |          |  
* -----          -----  
*/
```



```
/*-----*/
/* Includes                                     */
/*-----*/
#include "DrvLCD.h"
#include "DrvREG32.h"
#include "DrvSPI32.h"
#include "HY16F198.h"
#include "System.h"
#include "SPI_Flash.h"
#include "my define.h"
#include "Display.h"

/*-----*/
/* STRUCTURES                                   */
/*-----*/
volatile typedef union _MCUSTATUS
{
    char _byte;
    struct
    {
        unsigned b_ADCdone:1;
        unsigned b_TMAdone:1;
        unsigned b_TMBdone:1;
        unsigned b_TMC0done:1;
        unsigned b_TMC1done:1;
        unsigned b_RTCdone:1;
        unsigned b_UART_TxDone:1;
        unsigned b_UART_RxDone:1;
    };
} MCUSTATUS;

/*-----*/
/* DEFINITIONS                                   */
/*-----*/
#define FlashAddress 0x000000

/*-----*/
```

```
/* Global CONSTANTS */
/*-----*/
unsigned char Flash_Write_Buffer[256];
unsigned char Flash_Read_Buffer[256];
unsigned short Flash_ID;

/*-----*/
/* Function PROTOTYPES */
/*-----*/
void Delay(unsigned int num);

/*-----*/
/* MAIN function */
/*-----*/
int main(void)
{
    const unsigned char String1[]={
        "Hycon Technology was established in July, 2007 in Taipei, Taiwan. We dedicate ourselves to develop high precision and low drift
        analog signal related processing ICs." };
    const unsigned char String2[]={
        "The identity stands for the vision and values of Hycon Technology- To be the ideal solution partner in the area of analog circuit." };
    unsigned short index_d,Size;

    InitalSPI();
    DisplayInit();
    ClearLCDframe();
    Delay(10000);
    DisplayHYcon();
    Delay(10000);

    Flash_ID=SpiFlash_ReadMidDid(); //If correct, Flash_ID=0xEF12

    //Test1 : 16F write String1 to Flash, and Read out
    Size=sizeof(String1);
    SpiFlash_ChipErase(); //Erase DATA
    Delay(256);
    SpiFlash_ReadData(Flash_Read_Buffer,FlashAddress,Size); //Read DATA
```

```
Delay(256);

for( index_d=0;index_d<Size;index_d++)
{
    Flash_Write_Buffer[index_d]=String1[index_d];
}
SpiFlash_PageProgram(Flash_Write_Buffer,FlashAddress,Size); //Write DATA
Delay(256);
SpiFlash_ReadData(Flash_Read_Buffer,FlashAddress,Size); //Read DATA
Delay(256);

for( index_d=0;index_d<Size;index_d++)
{
    if(Flash_Read_Buffer[index_d]!=String1[index_d])
    {
        LCD_DATA_DISPLAY(1);
        while(1);
    }
    else
        LCD_DATA_DISPLAY(0);
}

//Test2 : 16F write String2 to Flash, and Read out
Size=sizeof(String2);
SpiFlash_SectorErase(0x00); //Erase DATA
Delay(256);
SpiFlash_ReadData(Flash_Read_Buffer,FlashAddress,Size); //Read DATA
Delay(256);

for( index_d=0;index_d<Size;index_d++)
{
    Flash_Write_Buffer[index_d]=String2[index_d];
}
SpiFlash_PageProgram(Flash_Write_Buffer,FlashAddress,Size); //Write DATA
Delay(256);
SpiFlash_ReadData(Flash_Read_Buffer,FlashAddress,Size); //Read DATA
Delay(256);
```

```
for( index_d=0;index_d<Size;index_d++)
{
    if(Flash_Read_Buffer[index_d]!=String2[index_d])
    {
        LCD_DATA_DISPLAY(1);                //If error, LCD Display "1"
        while(1);
    }
    else
        LCD_DATA_DISPLAY(123);            //If correct, LCD Display "123"
}

while(1);
return 0;
}

/*-----*/
/* Function Name: HW0_ISR()                */
/* Description   : I2C/UART/SPI interrupt Service Routine (HW0).          */
/* Arguments    : None.                */
/* Return Value : None.                */
/* Remark      :                        */
/*-----*/
void HW0_ISR(void)
{

}

/*-----*/
/* Function Name: HW1_ISR()                */
/* Description   : WDT & RTC & Timer A/B/C interrupt Service Routine (HW1). */
/* Arguments    : None.                */
/* Return Value : None.                */
/* Remark      :                        */
/*-----*/
void HW1_ISR(void)
{

}
```

HY16F19 系列

HYCON IP 使用說明書

```
/*-----*/
/* Function Name: HW2_ISR() */
/* Description : ADC interrupt Service Routine (HW2). */
/* Arguments : None. */
/* Return Value : None. */
/* Remark : */
/*-----*/
void HW2_ISR(void)
{

}
/*-----*/
/* Function Name: HW3_ISR() */
/* Description : CMP & OPA interrupt Service Routine (HW3). */
/* Arguments : None. */
/* Return Value : None. */
/* Remark : */
/*-----*/
void HW3_ISR(void)
{

}
/*-----*/
/* Function Name: HW4_ISR() */
/* Description : PT1 interrupt Service Routine (HW4). */
/* Arguments : None. */
/* Return Value : None. */
/* Remark : */
/*-----*/
void HW4_ISR(void)
{

}
/*-----*/
/* Function Name: HW5_ISR() */
/* Description : PT2 interrupt Service Routine (HW5). */
/* Arguments : None. */
/* Return Value : None. */
```

```
/* Remark      :                                          */
/*-----*/
void HW5_ISR(void)
{

}
/*-----*/
/* Function Name: HW7_ISR()                               */
/* Description   : UART2 interrupt Service Routine (HW7). */
/* Arguments    : None.                                   */
/* Return Value : None.                                   */
/* Remark      :                                          */
/*-----*/
void HW7_ISR(void)
{

}
/*-----*/
/* Function Name: HW8_ISR()                               */
/* Description   : TMB2 interrupt Service Routine (HW8).  */
/* Arguments    : None.                                   */
/* Return Value : None.                                   */
/* Remark      :                                          */
/*-----*/
void HW8_ISR(void)
{

}
/*-----*/
/* Function Name: tlb_exception_handler()                 */
/* Description   : Exception Service Routines.           */
/* Arguments    : None.                                   */
/* Return Value : None.                                   */
/* Remark      :                                          */
/*-----*/
void tlb_exception_handler()
{
    asm("nop"); //procedure define by customer.
}
```

HY16F19 系列

HYCON IP 使用說明書

```
asm("nop");  
}  
/*-----*/  
/* Software Delay Subroutines */  
/*-----*/  
void Delay(unsigned int num)  
{  
    for(;num>0;num--)  
        asm("NOP");  
}  
  
/*-----*/  
/* End Of File */  
/*-----*/
```

16. 通訊 IP(UART)

16.1. 範例名稱

HY16F198B_UART

16.2. 範例說明

(1)HY16F198B 使用 UART 做 TX 與 RX 傳輸範例程式

(2)程式開頭可以透過`//#define PORT9` 來選擇 UART Port 是要工作在 PT2 port 或著 PT9 port. 如果是 Port2 則 TX=PT2.0, RX=PT2.1. 如果是 Port9 則 TX=PT9.4, RX=PT9.5.

(3)程式開頭可以透過`#define HAO_2MHZ/ HAO_4MHZ/ HAO_10MHZ/ HAO_16MHZ` 來選擇晶片工作頻率

(4)程式開始執行, UART 會一直送字串' ABCDEF' , 直到收到' abcdef' 字串, 才會送出自串' abcdef' 並且 TX 停止傳送. 當收到不是字串' abcdef' , 則會再開始送' ABCDEF' 字串.

16.3. 軟體流程

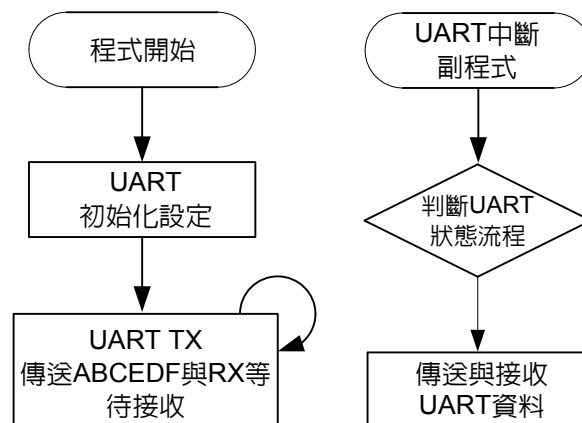

16.4. 程式碼

```
/*
 *
 * Copyright (c) 2016-2026 HYCON Technology, Inc.
 * All rights reserved.
 * HYCON Technology <www.hycontek.com>
 *
 * HYCON reserves the right to amend this code without notice at any time.
 * HYCON assumes no responsibility for any errors appeared in the code,
 * and HYCON disclaims any express or implied warranty, relating to sale
 * and/or use of this code including liability or warranties relating
 * to fitness for a particular purpose, or infringement of any patent,
 * copyright or other intellectual property right.
 *
 * -----
 * Project Name : HY16F198B_UART
 * IDE tooling : AndeSight C/C++ IDE, version: 2.1.1 Build ID : 201608241332
 * Device Ver. : HY16F_RDSp3_DeviceV0.2 crt0.o for HY16F19xB MCU.
 * Library Ver. : 1.3
 * MCU Device :
 * Description :
 * Created Date : 2018/2/18
 * Created by :
 *
 * Program Description:
 * -----
 */
/*-----*/
/* Includes */
/*-----*/
#include "DrvClock.h"
#include "DrvGPIO.h"
#include "DrvUART.h"
#include "HY16F198.h"
#include "System.h"
#include "my define.h"
```

```
/*-----*/
/* STRUCTURES */
/*-----*/
volatile typedef union _MCUSTATUS
{
    char _byte;
    struct
    {
        unsigned b_ADCdone:1;
        unsigned b_TMAdone:1;
        unsigned b_TMBdone:1;
        unsigned b_TMC0done:1;
        unsigned b_TMC1done:1;
        unsigned b_RTCdone:1;
        unsigned b_UART_TxDone:1;
        unsigned b_UART_RxDone:1;
    };
} MCUSTATUS;

/*-----*/
/* DEFINITIONS */
/*-----*/

#define PORT9
#define HSRC //Internal HAO
#define HSXT //External 4MHz

#define HAO_2MHZ
#define HAO_4MHZ
#define HAO_10MHZ
#define HAO_16MHZ

#if defined(PORT9)
#define UART_PORT E_PT9
#define UART_TXD BIT4
#define UART_RXD BIT5
#else
#define UART_PORT E_PT2
```

HY16F19 系列

HYCON IP 使用說明書

```
#define UART_TXD BIT0
#define UART_RXD BIT1
#endif

#define Uart_RX_BufferSize 6
#define Uart_TX_BufferSize 8

/*-----*/
/* Global CONSTANTS */
/*-----*/

unsigned char UartRxBuffer[Uart_RX_BufferSize]={0},UartTxBuffer[Uart_TX_BufferSize]={0};
unsigned char UartTxIndex,UartTxLength,UartRxIndex,UartRxLength;
MCUSTATUS MCUSTATUSbits;

unsigned char UartRxBuffer_Command[Uart_RX_BufferSize]=
{
0x61,0x62,0x63,0x64,0x65,0x66 //ASCII KEYWORD = abcdef
};
/*-----*/
/* Function PROTOTYPES */
/*-----*/

void Delay(unsigned int num);
void InitalUart(void);
void InitalClock(void);
/*-----*/
/* MAIN function */
/*-----*/

int main(void)
{
    unsigned char Stop_To_Send_UART=DISABLE;
    InitalClock();
    InitalUart();
    MCUSTATUSbits._byte = 0;
    MCUSTATUSbits.b_UART_TxDone=ENABLE;
    SYS_EnableGIE(4,0x1FF); //Enable GIE(Global Interrupt)

    UartTxIndex=0;
    UartRxIndex=0;
```

```
while(1)
{

//UART RX
if(MCUSTATUSbits.b_UART_RxDone==ENABLE)
{

if(
(UartRxBuffer[5]==UartRxBuffer_Command[5] && UartRxBuffer[4]==UartRxBuffer_Command[4]) &&
(UartRxBuffer[3]==UartRxBuffer_Command[3] && UartRxBuffer[2]==UartRxBuffer_Command[2]) &&
(UartRxBuffer[1]==UartRxBuffer_Command[1] && UartRxBuffer[0]==UartRxBuffer_Command[0])
)
{
//if UART receive == 0x61(a)0x62(b)0x63(c)0x64(d)0x65(e)0x66(f)
//send out 0x61(a)0x62(b)0x63(c)0x64(d)0x65(e)0x66(f) and stop to send out
Stop_To_Send_UART=ENABLE; //UART stop to send out ABCDEF
for(UartTxLength=0;UartTxLength<=Uart_TX_BufferSize;UartTxLength++)
{
UartTxBuffer[UartTxLength]=UartRxBuffer[UartTxLength];
if(UartTxLength==Uart_RX_BufferSize)
{
UartRxIndex=0;
MCUSTATUSbits.b_UART_TxDone=DISABLE;
DrvUART_EnableInt(ENABLE,DISABLE); //Enable UART Tx Interrupt, Disable UART Rx Interrupt
while(!MCUSTATUSbits.b_UART_TxDone); //If MCUSTATUSbits.b_UART_TxDone=DISABLE, stop at here
}
}
}
else
{
//if UART receive != 0x61(a)0x62(b)0x63(c)0x64(d)0x65(e)0x66(f)
//User defined at here
Stop_To_Send_UART=DISABLE; //UART start to send out ABCDEF
}
UartRxIndex=0; //When finished the data reception. Set UartRxIndex=0
MCUSTATUSbits.b_UART_RxDone=DISABLE;
}
}
```

```
//UART TX
if(MCUSTATUSbits.b_UART_TxDone==ENABLE && Stop_To_Send_UART==DISABLE )
{
    UartTxBuffer[7]='\r';
    UartTxBuffer[6]='\n';
    UartTxBuffer[5]=0x46; //F
    UartTxBuffer[4]=0x45; //E
    UartTxBuffer[3]=0x44; //D
    UartTxBuffer[2]=0x43; //C
    UartTxBuffer[1]=0x42; //B
    UartTxBuffer[0]=0x41; //A
    MCUSTATUSbits.b_UART_TxDone=DISABLE;
    UartTxLength=8;
    UartTxIndex=0;
    DrvUART_EnableInt(ENABLE,ENABLE); //Enable UART Tx Interrupt;Enable UART Rx Interrupt
    while(!MCUSTATUSbits.b_UART_TxDone); //If MCUSTATUSbits.b_UART_TxDone=DISABLE, stop at here
}

}

}

/*-----*/
/* Function Name: HW0_ISR */
/* Description : I2C/UART/SPI interrupt Service Routine (HW0). */
/* Arguments : None. */
/* Return Value : None. */
/* Remark : */
/*-----*/
void HW0_ISR(void)
{
    if(DrvUART_GetRxFlag())
    {
        UartRxBuffer[UartRxIndex]=DrvUART_Read();
        UartRxIndex++;
        if(UartRxIndex>=Uart_RX_BufferSize)
        {
            UartRxIndex=0;
        }
    }
}
```

```
MCUSTATUSbits.b_UART_RxDone=ENABLE;
}
DrvUART_ClrRxFlag();
}

if(DrvUART_GetTxFlag())
{
if(MCUSTATUSbits.b_UART_TxDone==DISABLE)
{
DrvUART_Write(UartTxBuffer[UartTxIndex++]);
DrvUART_ClrTxFlag();
if(UartTxIndex>=UartTxLength)
{
DrvUART_EnableInt(ENABLE,ENABLE); //ENABLE UART Tx Interrupt, ENABLE UART Rx Interrupt
MCUSTATUSbits.b_UART_TxDone=ENABLE;
UartTxIndex=0;
}
}
if(MCUSTATUSbits.b_UART_TxDone==ENABLE)
{
DrvUART_EnableInt(DISABLE,ENABLE); //DISABLE UART Tx Interrupt, ENABLE UART Rx Interrupt
DrvUART_ClrTxFlag();
}
}

}
/*-----*/
/* Function Name: HW1_ISR() */
/* Description : WDT & RTC & Timer A/B/C interrupt Service Routine (HW1). */
/* Arguments : None. */
/* Return Value : None. */
/* Remark : */
/*-----*/
void HW1_ISR(void)
{

}
/*-----*/
```

```
/* Function Name: HW2_ISR() */
/* Description : ADC interrupt Service Routine (HW2). */
/* Arguments : None. */
/* Return Value : None. */
/* Remark : */
/*-----*/
void HW2_ISR(void)
{

}
/*-----*/
/* Function Name: HW3_ISR() */
/* Description : CMP & OPA interrupt Service Routine (HW3). */
/* Arguments : None. */
/* Return Value : None. */
/* Remark : */
/*-----*/
void HW3_ISR(void)
{

}
/*-----*/
/* Function Name: HW4_ISR() */
/* Description : PT1 interrupt Service Routine (HW4). */
/* Arguments : None. */
/* Return Value : None. */
/* Remark : */
/*-----*/
void HW4_ISR(void)
{

}
/*-----*/
/* Function Name: HW5_ISR() */
/* Description : PT2 interrupt Service Routine (HW5). */
/* Arguments : None. */
/* Return Value : None. */
/* Remark : */
```

```
/*-----*/
void HW5_ISR(void)
{

}
/*-----*/
/* Function Name: HW7_ISR() */
/* Description : UART2 interrupt Service Routine (HW7). */
/* Arguments : None. */
/* Return Value : None. */
/* Remark : */
/*-----*/
void HW7_ISR(void)
{

}
/*-----*/
/* Function Name: HW8_ISR() */
/* Description : TMB2 interrupt Service Routine (HW8). */
/* Arguments : None. */
/* Return Value : None. */
/* Remark : */
/*-----*/
void HW8_ISR(void)
{

}
/*-----*/
/* Function Name: tlb_exception_handler() */
/* Description : Exception Service Routines. */
/* Arguments : None. */
/* Return Value : None. */
/* Remark : */
/*-----*/
void tlb_exception_handler()
{
    asm("nop"); //procedure define by customer.
    asm("nop");
}
```



```
}

/*-----*/
/* Function Name: InitalClock() */
/* Description : CLOCK Initial Subroutines. */
/* Arguments : None. */
/* Return Value : None. */
/* Remark : */
/*-----*/

void InitalClock(void)
{

#if defined(HSRC)
    #if defined(HAO_2MHZ)
        //Clock INIT 2MHZ
        DrvCLOCK_EnableHighOSC(E_INTERNAL,10); //Select HSRC
        DrvCLOCK_SelectIHOSC(0); //Select internal 2MHZ
        DrvCLOCK_SelectMCUClock(0,0); //CPU CLOCK IS 'hs_ck/1'
        DrvCLOCK_CalibrateHAO(0); //Calibration 1.843MHz
    #endif
    #if defined(HAO_4MHZ)
        //Clock INIT 4MHZ
        DrvCLOCK_EnableHighOSC(E_INTERNAL,10); //Select HSRC
        DrvCLOCK_SelectIHOSC(1); //Select internal 4MHZ
        DrvCLOCK_SelectMCUClock(0,0); //CPU CLOCK IS 'hs_ck/1'
        DrvCLOCK_CalibrateHAO(1); //Calibration 4.147MHz
    #endif
    #if defined(HAO_10MHZ)
        //Clock INIT 10MHZ
        DrvCLOCK_EnableHighOSC(E_INTERNAL,10); //Select HSRC
        DrvCLOCK_SelectIHOSC(2); //Select internal 10MHZ
        DrvCLOCK_SelectMCUClock(0,0); //CPU CLOCK IS 'hs_ck/1'
        DrvCLOCK_CalibrateHAO(2); //Calibration 9.216MHz
    #endif
    #if defined(HAO_16MHZ)
        //Clock INIT 16MHZ
        DrvCLOCK_EnableHighOSC(E_INTERNAL,10); //Select HSRC
        DrvCLOCK_SelectIHOSC(3); //Select internal 16MHZ
```

```
DrvCLOCK_SelectMCUClock(0,0);           //CPU CLOCK IS 'hs_ck/1'
DrvCLOCK_CalibrateHAO(3);                //Calibration 15.667MHz
#endif
#endif

#if defined(HSXT)
    DrvCLOCK_EnableHighOSC (E_EXTERNAL,50);
#endif
}

/*-----*/
/* Function Name: InitalUart()           */
/* Description   : UART Initial Subroutines. */
/* Arguments    : None.                  */
/* Return Value : None.                  */
/* Remark      :                          */
/*-----*/

void InitalUart(void)
{

#if defined(HSRC)
    DrvUART_ClkEnable(1,0);              //Choose the internal HAO as clock source
    #if defined(PORT9)
        #if defined(HAO_2MHZ)
            DrvUART_Open(1843,B9600,DRVUART_PARITY_NONE,DRVUART_DATABITS_8,DRVUART_STOPBITS_1,7);
        #endif
        #if defined(HAO_4MHZ)
            DrvUART_Open(4147,B9600,DRVUART_PARITY_NONE,DRVUART_DATABITS_8,DRVUART_STOPBITS_1,7);
        #endif
        #if defined(HAO_10MHZ)
            DrvUART_Open(9216,B9600,DRVUART_PARITY_NONE,DRVUART_DATABITS_8,DRVUART_STOPBITS_1,7);
        #endif
        #if defined(HAO_16MHZ)
            DrvUART_Open(15667,B9600,DRVUART_PARITY_NONE,DRVUART_DATABITS_8,DRVUART_STOPBITS_1,7);
        #endif
    #endif
    #else //PORT2
        #if defined(HAO_2MHZ)
            DrvUART_Open(1843,B9600,DRVUART_PARITY_NONE,DRVUART_DATABITS_8,DRVUART_STOPBITS_1,2);
        #endif
    #endif
}
```

```
#endif
#if defined(HAO_4MHZ)
DrvUART_Open(4147,B9600,DRVUART_PARITY_NONE,DRVUART_DATABITS_8,DRVUART_STOPBITS_1,2);
#endif
#if defined(HAO_10MHZ)
DrvUART_Open(9216,B9600,DRVUART_PARITY_NONE,DRVUART_DATABITS_8,DRVUART_STOPBITS_1,2);
#endif
#if defined(HAO_16MHZ)
DrvUART_Open(15667,B9600,DRVUART_PARITY_NONE,DRVUART_DATABITS_8,DRVUART_STOPBITS_1,2);
#endif
#endif
#endif

//1843 : oscillator frequency 2MHz Unit After Calibration HAO = 1843kHz
//4147 : oscillator frequency 4MHz Unit After Calibration HAO = 4147kHz
//9216 : oscillator frequency 10MHz Unit After Calibration HAO = 9216kHz
//15667 : oscillator frequency 16MHz Unit After Calibration HAO = 15667kHz

//None parity
//8 data bits.
//7 : Port 9.4 =TX, Port 9.5 =RX
//2 : Port 2.0 =TX, Port 2.1 =RX

#if defined(HSXT)
    DrvUART_ClkEnable(0,0);          //Choose the external 4MHz OSC as clock source
    DrvUART_Open(4000,B9600,DRVUART_PARITY_NONE,DRVUART_DATABITS_8,DRVUART_STOPBITS_1,2);
#endif

#if defined(PORT9)
    DrvGPIO_LCDIOOpen(UART_PORT, UART_TXD, E_IO_OUTPUT);
    DrvGPIO_LCDIOOpen(UART_PORT, UART_RXD, E_IO_INPUT);
#else
    DrvGPIO_Open(UART_PORT,UART_TXD,E_IO_OUTPUT);
    DrvGPIO_Open(UART_PORT,UART_RXD,E_IO_INPUT);
    DrvGPIO_Open(UART_PORT,UART_RXDIUART_TXD,E_IO_PullHigh);
#endif

DrvGPIO_ClkGenerator(E_HS_CK,1);
DrvUART_EnableInt(ENABLE,ENABLE); //Enable UART Tx Interrupt, Enable UART Rx Interrupt
```

HY16F19 系列

HYCON IP 使用說明書

```
DrvUART_Disable_AutoBaudrate();  
DrvUART_Close();  
DrvUART_Enable();  
}  
  
/*-----*/  
/* Software Delay Subroutines */  
/*-----*/  
void Delay(unsigned int num)  
{  
    for(;num>0;num--)  
        asm("NOP");  
}  
  
/*-----*/  
/* End Of File */  
/*-----*/
```

17. 通訊 IP(UART2)

17.1. 範例名稱

HY16F198B_UART2

17.2. 範例說明

(1)HY16F198B 使用 UART2 做 TX 與 RX 傳輸範例程式

(2)程式開頭可以透過`//#define PORT9` 來選擇 UART2 Port 是要工作在 PT2 port 或著 PT9 port. 如果是 Port2 則 TX=PT2.2, RX=PT2.3. 如果是 Port9 則 TX=PT9.6, RX=PT9.7.

(3)程式開頭可以透過`#define HAO_2MHZ/ HAO_4MHZ/ HAO_10MHZ/ HAO_16MHZ` 來選擇晶片工作頻率

(4)程式開始執行, UART2 會一直送字串' ABCDEF' , 直到收到' abcdef' 字串, 才會送出自串' abcdef' 並且 TX 停止傳送. 當收到不是字串' abcdef' , 則會再開始送' ABCDEF' 字串.

17.3. 軟體流程

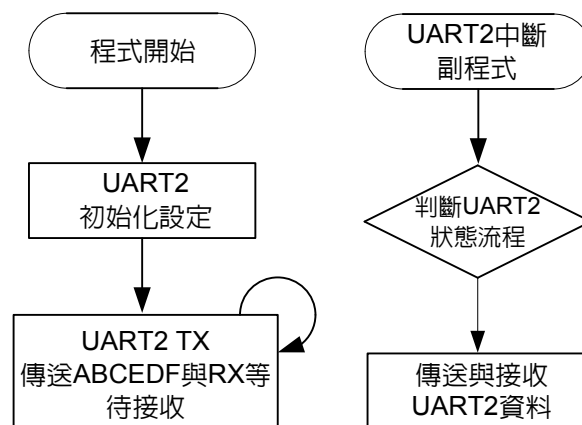

17.4. 程式碼

```
/******  
*  
* Copyright (c) 2016-2026 HYCON Technology, Inc.  
* All rights reserved.  
* HYCON Technology <www.hycontek.com>  
*  
* HYCON reserves the right to amend this code without notice at any time.  
* HYCON assumes no responsibility for any errors appeared in the code,  
* and HYCON disclaims any express or implied warranty, relating to sale  
* and/or use of this code including liability or warranties relating  
* to fitness for a particular purpose, or infringement of any patent,  
* copyright or other intellectual property right.  
*  
* -----  
* Project Name : HY16F198B_UART2  
* IDE tooling : AndeSight C/C++ IDE, version: 2.1.1 Build ID : 201608241332  
* Device Ver. : HY16F_RDSp3_DeviceV0.2 crt0.o for HY16F19xB MCU.  
* Library Ver. : 1.3  
* MCU Device :  
* Description :  
* Created Date : 2018/2/18  
* Created by :  
*  
* Program Description:  
* -----  
*****/  
/*-----*/  
/* Includes */  
/*-----*/  
#include "DrvClock.h"  
#include "DrvGPIO.h"  
#include "DrvUART.h"  
#include "HY16F198.h"  
#include "System.h"  
#include "my define.h"
```

HY16F19 系列

HYCON IP 使用說明書

```
/*-----*/
/* STRUCTURES                                                                    */
/*-----*/

volatile typedef union _MCUSTATUS
{
    char _byte;
    struct
    {
        unsigned b_ADCdone:1;
        unsigned b_TMAdone:1;
        unsigned b_TMBdone:1;
        unsigned b_TMC0done:1;
        unsigned b_TMC1done:1;
        unsigned b_RTCdone:1;
        unsigned b_UART2_TxDone:1;
        unsigned b_UART2_RxDone:1;
    };
} MCUSTATUS;

/*-----*/
/* DEFINITIONS                                                                    */
/*-----*/

#define PORT9
#define HSRC //Internal HAO
#define HSXT //External 4MHz

#define HAO_2MHZ
#define HAO_4MHZ
#define HAO_10MHZ
#define HAO_16MHZ

#if defined(PORT9)
#define UART2_PORT E_PT9
#define UART2_TXD BIT6
#define UART2_RXD BIT7
#else
#define UART2_PORT E_PT2
```

```
#define UART2_TXD BIT2
#define UART2_RXD BIT3
#endif

#define Uart2_RX_BufferSize 6
#define Uart2_TX_BufferSize 8

/*-----*/
/* Global CONSTANTS */
/*-----*/

unsigned char Uart2RxBuffer[Uart2_RX_BufferSize]={0},Uart2TxBuffer[Uart2_TX_BufferSize]={0};
unsigned char Uart2TxIndex,Uart2TxLength,Uart2RxIndex,Uart2RxLength;
MCUSTATUS MCUSTATUSbits;

unsigned char Uart2RxBuffer_Command[Uart2_RX_BufferSize]=
{
0x61,0x62,0x63,0x64,0x65,0x66 //ASCII KEYWORD = abcdef
};
/*-----*/
/* Function PROTOTYPES */
/*-----*/

void Delay(unsigned int num);
void InitalUart2(void);
void InitalClock(void);

/*-----*/
/* MAIN function */
/*-----*/

int main(void)
{

unsigned char Stop_To_Send_UART2=DISABLE;
InitalClock();
InitalUart2();
MCUSTATUSbits._byte = 0;
MCUSTATUSbits.b_UART2_TxDone=ENABLE;
SYS_EnableGIE(4,0x1FF); //Enable GIE(Global Interrupt)
```



```
Uart2TxIndex=0;
Uart2RxIndex=0;

while(1)
{

//UART2 RX
if(MCUSTATUSbits.b_UART2_RxDone==ENABLE)
{

if(
(Uart2RxBuffer[5]==Uart2RxBuffer_Command[5] && Uart2RxBuffer[4]==Uart2RxBuffer_Command[4]) &&
(Uart2RxBuffer[3]==Uart2RxBuffer_Command[3] && Uart2RxBuffer[2]==Uart2RxBuffer_Command[2]) &&
(Uart2RxBuffer[1]==Uart2RxBuffer_Command[1] && Uart2RxBuffer[0]==Uart2RxBuffer_Command[0])
)
{
//if UART2 receive == 0x61(a)0x62(b)0x63(c)0x64(d)0x65(e)0x66(f)
//send out 0x61(a)0x62(b)0x63(c)0x64(d)0x65(e)0x66(f) and stop to send out
Stop_To_Send_UART2=ENABLE; //UART stop to send out ABCDEF
for(Uart2TxLength=0;Uart2TxLength<=Uart2_TX_BufferSize;Uart2TxLength++)
{
Uart2TxBuffer[Uart2TxLength]=Uart2RxBuffer[Uart2TxLength];
if(Uart2TxLength==Uart2_RX_BufferSize)
{
Uart2RxIndex=0;
MCUSTATUSbits.b_UART2_TxDone=DISABLE;
DrvUART2_EnableInt(ENABLE,DISABLE); //Enable UART2 Tx Interrupt, Disable UART2 Rx Interrup
while(!MCUSTATUSbits.b_UART2_TxDone); //If MCUSTATUSbits.b_UART2_TxDone=DISABLE, stop at here
}
}
}
else
{
//if UART2 receive != 0x61(a)0x62(b)0x63(c)0x64(d)0x65(e)0x66(f)
//User defined at here
Stop_To_Send_UART2=DISABLE; //UART2 start to send out ABCDEF
}
Uart2RxIndex=0; //When finished the data reception. Set Uart2RxIndex=0
```

```
MCUSTATUSbits.b_UART2_RxDone=DISABLE;
}

//UART2 TX
if(MCUSTATUSbits.b_UART2_TxDone==ENABLE && Stop_To_Send_UART2==DISABLE )
{
    Uart2TxBuffer[7]='\r';
    Uart2TxBuffer[6]='\n';
    Uart2TxBuffer[5]=0x46; //F
    Uart2TxBuffer[4]=0x45; //E
    Uart2TxBuffer[3]=0x44; //D
    Uart2TxBuffer[2]=0x43; //C
    Uart2TxBuffer[1]=0x42; //B
    Uart2TxBuffer[0]=0x41; //A
    MCUSTATUSbits.b_UART2_TxDone=DISABLE;
    Uart2TxLength=8;
    Uart2TxIndex=0;
    DrvUART2_EnableInt(ENABLE,ENABLE);    //Enable UART2 Tx Interrupt;Enable UART2 Rx Interrupt
    while(!MCUSTATUSbits.b_UART2_TxDone); //If MCUSTATUSbits.b_UART2_TxDone=DISABLE, stop at here
}

}

}

/*-----*/
/* Function Name: HW0_ISR() */
/* Description : I2C/UART/SPI interrupt Service Routine (HW0). */
/* Arguments : None. */
/* Return Value : None. */
/* Remark : */
/*-----*/
void HW0_ISR(void)
{

}

/*-----*/
/* Function Name: HW1_ISR() */
/* Description : WDT & RTC & Timer A/B/C interrupt Service Routine (HW1). */
```

HY16F19 系列

HYCON IP 使用說明書

```
/* Arguments      : None.                */
/* Return Value : None.                */
/* Remark        :                       */
/*-----*/
void HW1_ISR(void)
{

}
/*-----*/
/* Function Name: HW2_ISR()             */
/* Description   : ADC interrupt Service Routine (HW2). */
/* Arguments     : None.                */
/* Return Value : None.                */
/* Remark       :                       */
/*-----*/
void HW2_ISR(void)
{

}
/*-----*/
/* Function Name: HW3_ISR()             */
/* Description   : CMP & OPA interrupt Service Routine (HW3). */
/* Arguments     : None.                */
/* Return Value : None.                */
/* Remark       :                       */
/*-----*/
void HW3_ISR(void)
{

}
/*-----*/
/* Function Name: HW4_ISR()             */
/* Description   : PT1 interrupt Service Routine (HW4). */
/* Arguments     : None.                */
/* Return Value : None.                */
/* Remark       :                       */
/*-----*/
void HW4_ISR(void)
```

```
{

}

/*-----*/
/* Function Name: HW5_ISR() */
/* Description : PT2 interrupt Service Routine (HW5). */
/* Arguments : None. */
/* Return Value : None. */
/* Remark : */
/*-----*/
void HW5_ISR(void)
{

}

/*-----*/
/* Function Name: HW7_ISR() */
/* Description : UART2 Interrupt Service Routines(HW7). */
/* Arguments : None. */
/* Return Value : None. */
/* Remark : */
/*-----*/
void HW7_ISR(void)
{

    if(DrvUART2_GetRxFlag())
    {
        Uart2RxBuffer[Uart2RxIndex]=DrvUART2_Read();
        Uart2RxIndex++;
        if(Uart2RxIndex>=Uart2_RX_BufferSize)
        {
            Uart2RxIndex=0;
            MCUSTATUSbits.b_UART2_RxDone=ENABLE;
        }
        DrvUART2_ClrRxFlag();
    }

    if(DrvUART2_GetTxFlag())
    {
```

```
if(MCUSTATUSbits.b_UART2_TxDone==DISABLE)
{
    DrvUART2_Write(Uart2TxBuffer[Uart2TxIndex++]);
    DrvUART2_ClrTxFlag();
    if(Uart2TxIndex>=Uart2TxLength)
    {
        DrvUART2_EnableInt(ENABLE,ENABLE); //ENABLE UART2 Tx Interrupt, ENABLE UART2 Rx Interrupt
        MCUSTATUSbits.b_UART2_TxDone=ENABLE;
        Uart2TxIndex=0;
    }
}

if(MCUSTATUSbits.b_UART2_TxDone==ENABLE)
{
    DrvUART2_EnableInt(DISABLE,ENABLE); //DISABLE UART2 Tx Interrupt, ENABLE UART2 Rx Interrupt
    DrvUART2_ClrTxFlag();
}

}

}

/*-----*/
/* Function Name: HW8_ISR() */
/* Description : TMB2 interrupt Service Routine (HW8). */
/* Arguments : None. */
/* Return Value : None. */
/* Remark : */
/*-----*/
void HW8_ISR(void)
{

}

/*-----*/
/* Function Name: tlb_exception_handler() */
/* Description : Exception Service Routines. */
/* Arguments : None. */
/* Return Value : None. */
/* Remark : */
```

```
/*-----*/
void tlb_exception_handler()
{
    asm("nop"); //procedure define by customer.
    asm("nop");
}
/*-----*/

/* Function Name: InitalClock() */
/* Description : CLOCK Initial Subroutines. */
/* Arguments : None. */
/* Return Value : None. */
/* Remark : */
/*-----*/

void InitalClock(void)
{

#ifdef HSRC
    #if defined(HAO_2MHZ)
        //Clock INIT 2MHZ
        DrvCLOCK_EnableHighOSC(E_INTERNAL,10); //Select HSRC
        DrvCLOCK_SelectIHOSC(0); //Select internal 2MHZ
        DrvCLOCK_SelectMCUClock(0,0); //CPU CLOCK IS 'hs_ck/1'
        DrvCLOCK_CalibrateHAO(0); //Calibration 1.843MHz
    #endif
    #if defined(HAO_4MHZ)
        //Clock INIT 4MHZ
        DrvCLOCK_EnableHighOSC(E_INTERNAL,10); //Select HSRC
        DrvCLOCK_SelectIHOSC(1); //Select internal 4MHZ
        DrvCLOCK_SelectMCUClock(0,0); //CPU CLOCK IS 'hs_ck/1'
        DrvCLOCK_CalibrateHAO(1); //Calibration 4.147MHz
    #endif
    #if defined(HAO_10MHZ)
        //Clock INIT 10MHZ
        DrvCLOCK_EnableHighOSC(E_INTERNAL,10); //Select HSRC
        DrvCLOCK_SelectIHOSC(2); //Select internal 10MHZ
        DrvCLOCK_SelectMCUClock(0,0); //CPU CLOCK IS 'hs_ck/1'
        DrvCLOCK_CalibrateHAO(2); //Calibration 9.216MHz
    #endif
#endif
}
```

```
#if defined(HAO_16MHZ)
//Clock INIT 16MHZ
DrvCLOCK_EnableHighOSC(E_INTERNAL,10);           //Select HSRC
DrvCLOCK_SelectIHOSC(3);                         //Select internal 16MHZ
DrvCLOCK_SelectMCUClock(0,0);                   //CPU CLOCK IS 'hs_ck/1'
DrvCLOCK_CalibrateHAO(3);                       //Calibration 15.667MHz
#endif
#endif

#if defined(HSXT)
    DrvCLOCK_EnableHighOSC (E_EXTERNAL,50);
#endif
}

/*-----*/
/* Function Name: InitalUart2                                */
/* Description   : UART2 Initial Subroutines.                */
/* Arguments    : None.                                     */
/* Return Value : None.                                     */
/* Remark      :                                           */
/*-----*/

void InitalUart2(void)
{

#if defined(HSRC)
    DrvUART2_ClkEnable(1,0);           //Choose the internal HAO as clock source
    #if defined(PORT9)
        #if defined(HAO_2MHZ)
            DrvUART2_Open(1843,B9600,DRVUART_PARITY_NONE,DRVUART_DATABITS_8,DRVUART_STOPBITS_1,7);
        #endif
        #if defined(HAO_4MHZ)
            DrvUART2_Open(4147,B9600,DRVUART_PARITY_NONE,DRVUART_DATABITS_8,DRVUART_STOPBITS_1,7);
        #endif
        #if defined(HAO_10MHZ)
            DrvUART2_Open(9216,B9600,DRVUART_PARITY_NONE,DRVUART_DATABITS_8,DRVUART_STOPBITS_1,7);
        #endif
        #if defined(HAO_16MHZ)
            DrvUART2_Open(15667,B9600,DRVUART_PARITY_NONE,DRVUART_DATABITS_8,DRVUART_STOPBITS_1,7);
        #endif
    #endif
#endif
}
```

```
#endif
#else //PORT2
    #if defined(HAO_2MHZ)
        DrvUART2_Open(1843,B9600,DRVUART_PARITY_NONE,DRVUART_DATABITS_8,DRVUART_STOPBITS_1,2);
    #endif
    #if defined(HAO_4MHZ)
        DrvUART2_Open(4147,B9600,DRVUART_PARITY_NONE,DRVUART_DATABITS_8,DRVUART_STOPBITS_1,2);
    #endif
    #if defined(HAO_10MHZ)
        DrvUART2_Open(9216,B9600,DRVUART_PARITY_NONE,DRVUART_DATABITS_8,DRVUART_STOPBITS_1,2);
    #endif
    #if defined(HAO_16MHZ)
        DrvUART2_Open(15667,B9600,DRVUART_PARITY_NONE,DRVUART_DATABITS_8,DRVUART_STOPBITS_1,2);
    #endif
#endif
#endif

//1843 : oscillator frequency 4MHz Unit After Calibration HAO = 1843kHz
//4147 : oscillator frequency 4MHz Unit After Calibration HAO = 4147kHz
//9216 : oscillator frequency 4MHz Unit After Calibration HAO = 9216kHz
//15667 : oscillator frequency 4MHz Unit After Calibration HAO = 15667kHz
//None parity
//8 data bits.
//7 : Port 9.6 =TX, Port 9.7 =RX
//2 : Port 2.2 =TX, Port 2.3 =RX

#if defined(HSXT)
    DrvUART2_ClkEnable(0,0);           //Choose the external OSC as clock source
    DrvUART2_Open(4000,B9600,DRVUART_PARITY_NONE,DRVUART_DATABITS_8,DRVUART_STOPBITS_1,2);
#endif

#if defined(PORT9)
    DrvGPIO_LCDIOOpen(UART2_PORT, UART2_TXD, E_IO_OUTPUT);
    DrvGPIO_LCDIOOpen(UART2_PORT, UART2_RXD, E_IO_INPUT);

#else
    DrvGPIO_Open(UART2_PORT,UART2_TXD,E_IO_OUTPUT);
    DrvGPIO_Open(UART2_PORT,UART2_RXD,E_IO_INPUT);
    DrvGPIO_Open(UART2_PORT,UART2_RXDIUART2_TXD,E_IO_PullHigh);
```



```
#endif
```

```
DrvUART2_EnableInt(ENABLE,ENABLE); //ENABLE UART2 Tx Interrupt, ENABLE UART2 Rx Interrupt
```

```
DrvUART2_Disable_AutoBaudrate();
```

```
DrvUART2_Close();
```

```
DrvUART2_Enable();
```

```
}
```

```
/*-----*/
```

```
/* Software Delay Subroutines */
```

```
/*-----*/
```

```
void Delay(unsigned int num)
```

```
{
```

```
    for(;num>0;num--)
```

```
        asm("NOP");
```

```
}
```

```
/*-----*/
```

```
/* End Of File */
```

```
/*-----*/
```

18. 通訊 IP(I2C)

18.1. 範例名稱

HY16F198B_I2C

18.2. 範例說明

- (1)HY16F198B 工作在 I2C Master Mode, 對 I2C EEPROM 24C02 做寫入與讀取控制範例.
- (2)範例程式內容包含 HY16F198B 之 I2C Master 設置初始化過程，並且對一個 I2C EEPROM(24C02)裝置做單次的資料寫入和讀取與連續的資料寫入讀取範例
- (3)程式第一段功能為做單次性的資料寫入和讀取在 EEPROM 裝置，首先由 I2C Master 寫入資料 0x01 在 EEPROM 的 WORD ADDRESS 0x00，然後再下 Read 指令讀回 EEPROM 的 WORD ADDRESS 0x00 位置，如果程式正確無誤，則會由 I2C Master 端讀回到 0x01 的數值資料。
- (4)程式第二段功能為做連續性的資料寫入和讀取在 EEPROM 裝置，從 EEPROM 的 WORD ADDRESS 0x01 開始寫入 4bytes 資料直到 WORD ADDRESS 0x04，再依序從 EEPROM 的 WORD ADDRESS 0x00 連續做 5 bytes 的資料讀取直到 0x04，觀察資料是否已經正確被寫入。
- (5)在本文範例程式裡面，當執行完程式第一段和第二段的正確的執行結果為 EEPROM Address 0x00 資料等於 0x01，Address 0x01 資料等於 0x02，Address 0x02 資料等於 0x03，Address 0x03 資料等於 0x04，Address 0x04 資料等於 0x05。

18.3. 系統設定

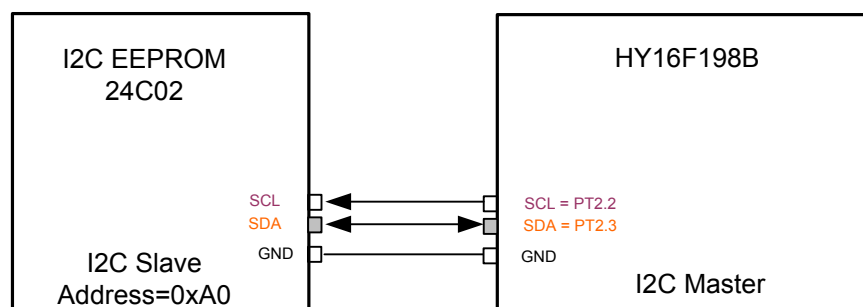

18.4. 軟體流程

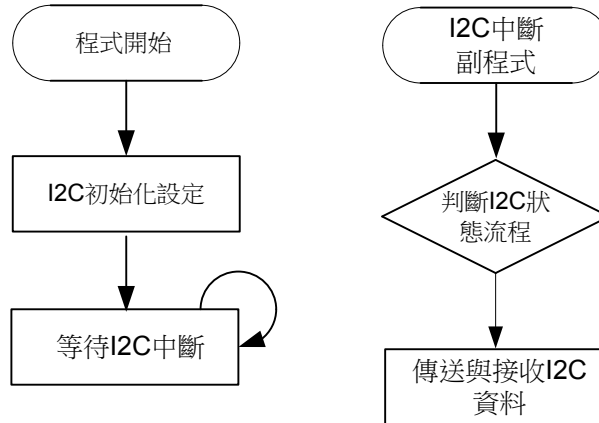

18.5. 程式碼

說明：在此僅貼上 main.c 程式內容做參考.

```

/*****
*
* Copyright (c) 2016-2026 HYCON Technology, Inc.
* All rights reserved.
* HYCON Technology <www.hycontek.com>
*
* HYCON reserves the right to amend this code without notice at any time.
* HYCON assumes no responsibility for any errors appeared in the code,
* and HYCON disclaims any express or implied warranty, relating to sale
* and/or use of this code including liability or warranties relating
* to fitness for a particular purpose, or infringement of any patent,
* copyright or other intellectual property right.
*
* -----
* Project Name : HY16F198B_I2C
* IDE tooling : AndeSight C/C++ IDE, version: 2.1.1 Build ID : 201608241332
* Device Ver. : HY16F_RDSp3_DeviceV0.2 crt0.o for HY16F19xB MCU.
* Library Ver. : 1.3
* MCU Device :
* Description :
* Created Date : 2018/2/18

```

HY16F19 系列 HYCON IP 使用說明書

```
* Created by :
*
* Program Description:
* -----
*
* HY16H198
* -----
*          |          -----
* PT2.3 | SDA <--> SDA IEEPROMI
* PT2.2 | SCK ---> SCK -----
*          |
* PT2.4 | LXIN
* PT2.5 | LXOUT
* GND   |
*          |
* -----
*****/
/*-----*/
/* Includes                                     */
/*-----*/
#include "HY16F198.h"
#include "DrvI2C.h"
#include "System.h"
#include "EEPROM_24Cxx.h"
#include "my define.h"

/*-----*/
/* DEFINITIONS                                   */
/*-----*/
#define I2C_PORT E_PT2
#define SCL_PIN 2
#define SDA_PIN 3
#define SCL_BIT BIT2
#define SDA_BIT BIT3
#define I2CBufferSize 256
#define I2C_WRITE 0x00 // I2C WRITE command
#define I2C_READ 0x01 // I2C READ command
/*-----*/
```

```
/* Global CONSTANTS */
/*-----*/
unsigned char I2C_Read_Buffer[I2CBufferSize];
unsigned char I2C_RW;
unsigned char I2C_TARGET; // Target I2C slave address
unsigned char I2C_Sendbuf[I2CBufferSize];
unsigned char I2C_Recbuf[I2CBufferSize];
unsigned char I2C_EndFlag;
unsigned int I2C_DataTxLen,I2C_DataTxIndex,I2C_DataRxLen,I2C_DataRxIndex;

/*-----*/
/* Function PROTOTYPES */
/*-----*/
void Delay(unsigned int num);

/*-----*/
/* Main Function */
/*-----*/
int main(void)
{
    unsigned int i;
    unsigned char EEPROM_WriteData[4] = {0x02,0x03,0x04,0x05};

    for(i=0;i<=I2CBufferSize;i++)
    {
        I2C_Read_Buffer[i]=0; //Initial I2C data buffer=0
    }

    DrvI2C_SetIOPin(5); //Setting io pin, 5: SCL=PT2.2;SDA=PT2.3
    DrvI2C_Open(0x63); //Enable I2C function and set I2C baud rate=5kHz
    //Default CPU clock is 2MHz, Data Baud Rate : (I2CLK)/[4x(CRG+1)]= 2000000/[4*(99+1)]=5kHz
    DrvI2C_EnableInt(2); // Enable I2C interrupt and error interrupt

    SYS_EnableGIE(4,0x1FF); //Enable GIE(Global Interrupt)

    // I2C single I2C_WRITE & I2C_READ
    EEPROM_ByteWrite(0x00,0x01); //Single Byte I2C_WRITE word address 0x00, and I2C_WRITE data 0x01
}
```

```
Delay(1000); //Delay for EEPROM 24C02 I2C_WRITE Cycle Time 5ms
I2C_Read_Buffer[0]=EEPROM_ByteRead(0x00); //Single Byte I2C_READ word address 0x00, the I2C_READ value is 0x01
Delay(1000); //Delay for EEPROM 24C02 I2C_WRITE Cycle Time 5ms

// I2C sequential I2C_WRITE & I2C_READ
EEPROM_WriteArray(0x01,EEPROM_WriteData,4); //I2C_WRITE array data to the word address from 0x01 to 0x04
Delay(1000); //Delay for EEPROM 24C02 I2C_WRITE Cycle Time 5ms
EEPROM_ReadArray(I2C_Read_Buffer, 0x00, 5); //sequential I2C_READ data from 0x00 to 0x04
Delay(1000); //Delay for EEPROM 24C02 I2C_WRITE Cycle Time 5ms

while(1);

}

/*-----*/
/* Function Name: HW0_ISR */
/* Description : I2C/UART/SPI interrupt Service Routine (HW0). */
/* Arguments : None. */
/* Return Value : None. */
/* Remark : */
/*-----*/

void HW0_ISR(void)
{
    unsigned char I2C_Status,I2C_IntFlag;

    I2C_IntFlag=DrvI2C_ReadIntFlag();
    if((I2C_IntFlag == E_DRVI2C_INT)||(I2C_IntFlag == E_DRVI2C_INT_ALL)) //Get I2C Interrupt Flag
    {
        I2C_Status=DrvI2C_GetStatusFlag(); //Get I2C Status Flag
        switch(I2C_Status)
        {
            case 0x90: //MACTFlag+RWFlag
                { //START has been transmitted
                    DrvI2C_WriteData(I2C_TARGET); //Send Slave Address & R/W Bit
                    DrvI2C_Ctrl(0,0,0,0); //Clear all I2C flag
                    break;
                };
            case 0x84: //MACTFlag+ACKFlag
```

```
{
    //Slave A + W has been transmitted. ACK has been received.
    DrvI2C_WriteData(I2C_Sendbuf[I2C_DataTxIndex++]); //Send Data to Slave
    DrvI2C_Ctrl(0,0,0,0); //Clear all I2C flag
    break;
};

case 0x80: //MACTFlag
{
    //Slave A + W has been transmitted. ACK has been received.
    DrvI2C_WriteData(I2C_Sendbuf[I2C_DataTxIndex++]); //Send Data to Slave
    DrvI2C_Ctrl(0,0,0,0); //Clear all I2C flag
    break;
};

case 0x30:
{
    DrvI2C_Ctrl(0,0,0,0); //Clear all I2C flag
    I2C_EndFlag=1;
    break;
};

case 0x8C: //MACTFlag+DFFlag+ACKFlag
{
    //DATA has been transmitted and ACK has been received
    if(I2C_DataTxIndex<I2C_DataTxLen)
    {
        DrvI2C_WriteData(I2C_Sendbuf[I2C_DataTxIndex++]); //Send Data to Slave
        DrvI2C_Ctrl(0,0,0,0); // Clear all I2C flag
    }
    else
    {
        if(I2C_RW == I2C_WRITE)
        {
            DrvI2C_Ctrl(0,1,0,0); //I2C as master sends STOP signal
            I2C_EndFlag=1;
        }
        else if(I2C_RW == I2C_READ)
            DrvI2C_Ctrl(1,0,0,0); //I2C as master sends START signal
        I2C_DataTxIndex=0;
    }
    break;
};

case 0x88: //MACTFlag+DFFlag
```

```
{ //DATA has been transmitted and NACK has been received
  DrvI2C_Ctrl(0,1,0,0); //I2C as master sends STOP signal
  I2C_DataTxIndex=0;
  I2C_EndFlag=1;
  break;
};

case 0xB0:
{ //A repeated START has been transmitted.
  DrvI2C_WriteData(I2C_TARGET | I2C_READ); //Send Slave Address & R/W Bit
  DrvI2C_Ctrl(0,0,0,0); //Clear all I2C flag
  break;
}

case 0x94: //MACTFlag+RWFlag+ACKFlag
{ //Slave A + R has been transmitted. ACK has been received.
  if(I2C_DataRxLen>1)
  {
    DrvI2C_Ctrl(0,0,0,1); //Set ACK bit
  }else{
    DrvI2C_Ctrl(0,0,0,0); //Clear all I2C flag
  }
  break;
};

case 0x9C: //MACTFlag+RWFlag+DFFlag+ACKFlag
{ //Data byte has been received. ACK has been transmitted.
  I2C_Recbuf[I2C_DataRxIndex++]=DrvI2C_ReadData();
  if((I2C_DataRxLen-1)>I2C_DataRxIndex)
  {
    DrvI2C_Ctrl(0,0,0,1); //Set ACK bit
  }
  else
  {
    DrvI2C_Ctrl(0,0,0,0); //Clear all I2C flag
  }
  break;
};

case 0x98: //MACTFlag+RWFlag+DFFlag
{ //Data byte has been received. NACK has been transmitted.
  I2C_Recbuf[I2C_DataRxIndex++]=DrvI2C_ReadData();
```



```
    DrvI2C_Ctrl(0,1,0,0); //I2C as master sends STOP signal
    I2C_EndFlag=1;
    break;
};
default:
{
    DrvI2C_Ctrl(0,0,0,0); //Clear all I2C flag
    I2C_EndFlag=1;
    break;
};
}
DrvI2C_ClearIRQ();
DrvI2C_ClearEIRQ();           //Clear EIRQFlag
DrvI2C_ClearIntFlag(0);      //Clear I2C Interrupt Flag(I2CIF)
}
if((I2C_IntFlag == E_DRVI2C_ERROR_INT)||(I2C_IntFlag == E_DRVI2C_INT_ALL)) //Get I2C Error Interrupt Flag
{
    I2C_EndFlag=1;
    DrvI2C_ClearIRQ();
    DrvI2C_ClearEIRQ();           //Clear EIRQFlag
    DrvI2C_ClearIntFlag(1);      //Clear I2C Interrupt Flag(I2CEIF)
    DrvI2C_Ctrl(0,0,0,0);      //Clear all I2C flag
}
SYS_EnableGIE(4,0x1FF);      //Enable GIE(Global Interrupt)
}
/*-----*/
/* Function Name: HW1_ISR() */
/* Description   : WDT & RTC & Timer A/B/C interrupt Service Routine (HW1). */
/* Arguments    : None. */
/* Return Value : None. */
/* Remark      : */
/*-----*/
void HW1_ISR(void)
{

}

/*-----*/
```

```
/* Function Name: HW2_ISR() */
/* Description : ADC interrupt Service Routine (HW2). */
/* Arguments : None. */
/* Return Value : None. */
/* Remark : */
/*-----*/
void HW2_ISR(void)
{

}
/*-----*/
/* Function Name: HW3_ISR() */
/* Description : CMP & OPA interrupt Service Routine (HW3). */
/* Arguments : None. */
/* Return Value : None. */
/* Remark : */
/*-----*/
void HW3_ISR(void)
{

}
/*-----*/
/* Function Name: HW4_ISR() */
/* Description : PT1 interrupt Service Routine (HW4). */
/* Arguments : None. */
/* Return Value : None. */
/* Remark : */
/*-----*/
void HW4_ISR(void)
{

}
/*-----*/
/* Function Name: HW5_ISR() */
/* Description : PT2 interrupt Service Routine (HW5). */
/* Arguments : None. */
/* Return Value : None. */
/* Remark : */
```

```
/*-----*/
void HW5_ISR(void)
{

}
/*-----*/
/* Function Name: HW7_ISR() */
/* Description : UART2 interrupt Service Routine (HW7). */
/* Arguments : None. */
/* Return Value : None. */
/* Remark : */
/*-----*/
void HW7_ISR(void)
{

}
/*-----*/
/* Function Name: HW8_ISR() */
/* Description : TMB2 interrupt Service Routine (HW8). */
/* Arguments : None. */
/* Return Value : None. */
/* Remark : */
/*-----*/
void HW8_ISR(void)
{

}
/*-----*/
/* Function Name: tlb_exception_handler() */
/* Description : Exception Service Routines. */
/* Arguments : None. */
/* Return Value : None. */
/* Remark : */
/*-----*/
void tlb_exception_handler()
{
    asm("nop"); //procedure define by customer.
    asm("nop");
}
```

}

/*-----*/

/* Software Delay Subroutines */

/*-----*/

void Delay(unsigned int num)

{

 for(;num>0;num--)

 asm("NOP");

}

/*-----*/

/* End Of File */

/*-----*/

19. 其他 IP(Power)

19.1. 範例名稱

HY16F198B_Power

19.2. 範例說明

- (1) HY16F198B 進入 Sleep 與 Idle Mode 範例程式
- (2) 硬體連接部分, 各腳位不浮接, 例如:腳位 EDIO 與 ECK 接 100k 歐姆到 GND.
- (3) 上電後按下 PT1.1 喚醒並且 LCD 顯示 50000。
- (4) 上電後按下 PT1.2 進入 Idle Mode 或 Sleep Mode, 進入 Idle Mode or Sleep Mode 是藉由程式開頭的#define IDLE_MODE 或#define SLEEP_MODE 來決定。
- (5) 此範例程式搭配 HY16F198B 硬體開發板, 可測量到 Sleep 耗電流約為 2.5uA, Idle 耗電流約為 3.5uA.

19.3. 軟體流程

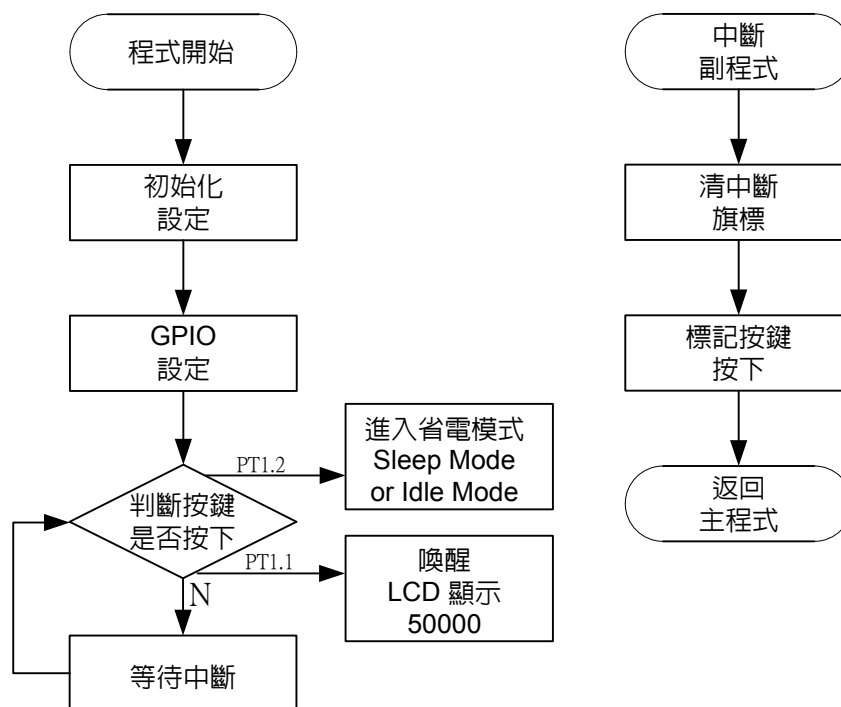

19.4. 程式碼

```

/*****
*
* Copyright (c) 2016-2026 HYCON Technology, Inc.
* All rights reserved.
* HYCON Technology <www.hycontek.com>
*
* HYCON reserves the right to amend this code without notice at any time.
* HYCON assumes no responsibility for any errors appeared in the code,
* and HYCON disclaims any express or implied warranty, relating to sale
* and/or use of this code including liability or warranties relating
* to fitness for a particular purpose, or infringement of any patent,
* copyright or other intellectual property right.
*
* -----
* Project Name : HY16F198B_Power
* IDE tooling : AndeSight C/C++ IDE, version: 2.1.1 Build ID : 201608241332
* Device Ver. : HY16F_RDSp3_DeviceV0.2 crt0.o for HY16F19xB MCU.
* Library Ver. : 1.3
* MCU Device :
* Description :
* Created Date : 2018/2/18
* Created by :
*
* Program Description:
* -----
*****/
/*-----*/
/* Includes */
/*-----*/
#include "DrvClock.h"
#include "DrvGPIO.h"
#include "DrvLCD.h"
#include "DrvPMU.h"
#include "DrvREG32.h"
#include "HY16F198.h"
#include "System.h"
#include "Display.h"
#include "my define.h"

/*-----*/
/* DEFINITIONS */
/*-----*/
#define KEY_PORT E_PT1
#define KEYIN0 BIT1
#define KEYIN1 BIT2

```

HY16F19 系列

HYCON IP 使用說明書

```
#define KEYIN0_PIN 1
#define KEYIN1_PIN 2

//#define IDLE_MODE
#define SLEEP_MODE
/*-----*/
/* STRUCTURES */
/*-----*/
typedef union _MCUSTATUS
{
    char _byte;
    struct
    {
        unsigned b_ADCdone:1;
        unsigned b_TMAdone:1;
        unsigned b_TMBdone:1;
        unsigned b_TMC0done:1;
        unsigned b_TMC1done:1;
        unsigned b_RTCdone:1;
        unsigned b_UART_TxDone:1;
        unsigned b_UART_RxDone:1;
    };
} MCUSTATUS;
typedef union _PTINTSTATUS
{
    char _byte;
    struct
    {
        unsigned b_PTINT0done:1;
        unsigned b_PTINT1done:1;
        unsigned b_PTINT2done:1;
        unsigned b_PTINT3done:1;
        unsigned b_PTINT4done:1;
        unsigned b_PTINT5done:1;
        unsigned b_PTINT6Done:1;
        unsigned b_PTINT7Done:1;
    };
} PTINTSTATUS;

/*-----*/
/* Global CONSTANTS */
/*-----*/
MCUSTATUS MCUSTATUSbits;
PTINTSTATUS PTINTSTATUSbits;
unsigned int PT11_IDF;
```

```
/*-----*/
/* Function PROTOTYPES                                     */
/*-----*/
void Delay(unsigned int num);

/*-----*/
/* Main Function                                           */
/*-----*/
int main(void)
{
    DisplayInit();
    ClearLCDframe();
    DrvGPIO_ClkGenerator(E_HS_CK,1);                       //Set IO sampling clock input source is HS_CK
    DrvGPIO_Open(KEY_PORT,KEYIN1|KEYIN0,E_IO_INPUT);      //set PT1.2/PT1.1 INPUT
    DrvGPIO_Open(KEY_PORT,KEYIN1|KEYIN0,E_IO_PullHigh);   //enable PT1.2/PT1.1 pull high R
    DrvGPIO_Open(KEY_PORT,KEYIN1|KEYIN0,E_IO_IntEnable); //PT1_1/PT1_2 interrupt enable
    DrvGPIO_IntTrigger(KEY_PORT,KEYIN1|KEYIN0,E_N_Edge); //PT1_1/PT1_2 interrupt trigger method is negative edge
    DrvGPIO_ClearIntFlag(KEY_PORT,KEYIN1|KEYIN0);        //clear PT1 interrupt flag
    PT1INTSTATUSbits._byte = 0;
    SYS_EnableGIE(4,0x1FF);                              //Enable GIE(Global Interrupt)

    while(1)
    {
        if(PT1INTSTATUSbits.b_PTINT1done)                //if PT1.1 low
        {
            LCD_DATA_DISPLAY(50000);
            PT1INTSTATUSbits.b_PTINT1done=0;
        }

        if(PT1INTSTATUSbits.b_PTINT2done)                //if PT1.2 low
        {

            PT11_IDF=DrvGPIO_PortIDIF(E_PT1) & 0x02;    //check wake up pin, PT1.1 IDF status
            if(PT11_IDF==0x02)
            {
                //Enter Sleep or Idle mode setting
                DrvLCD_VLCDMode(0);                      //LCD VLCD
                while((inw(0x41B00)&(1<<IDF))==0);     //Wait LCD Idle, IDF=20
                DrvPMU_LDO_LowPower(1);                  //SET low power mode
                DrvCLOCK_SelectMCUClock(E_LS_CK,1);     //SET CPUCKL=LPO/2
                DrvCLOCK_CloseIHOSC();                  //Close HAO
                #if defined(IDLE_MODE)
                SYS_LowPower(1);                        //Idle Mode, around 3.5uA
                #endif
                #if defined(SLEEP_MODE)
                SYS_LowPower(0);                        //sleep mode, around 2.5uA
                #endif
            }
        }
    }
}
```



```
    }
    //If wake up from Sleep or Idle, user can enable internal HAO first to do some application
    DrvPMU_LDO_LowPower(); //SET normal power mode
    DrvCLOCK_EnableHighOSC(E_INTERNAL,1);
    DrvCLOCK_SelectMCUClock(E_HS_CK,0); //SET CPUCKL=HAO/1
    DrvLCD_VLCDMode(E_VLCD30);
    PT1INTSTATUSbits.b_PTINT2done=0;

}
}
return 0;
}

/*-----*/
/* Function Name: HW0_ISR */
/* Description : I2C/UART/SPI interrupt Service Routine (HW0). */
/* Arguments : None. */
/* Return Value : None. */
/* Remark : */
/*-----*/
void HW0_ISR(void)
{

}
/*-----*/
/* Function Name: HW1_ISR */
/* Description : WDT & RTC & Timer A/B/C interrupt Service Routine (HW1). */
/* Arguments : None. */
/* Return Value : None. */
/* Remark : */
/*-----*/
void HW1_ISR(void)
{

}
/*-----*/
/* Function Name: HW2_ISR */
/* Description : ADC interrupt Service Routine (HW2). */
/* Arguments : None. */
/* Return Value : None. */
/* Remark : */
/*-----*/
void HW2_ISR(void)
{

}
/*-----*/
```

HY16F19 系列

HYCON IP 使用說明書

```
/* Function Name: HW3_ISR() */
/* Description : CMP & OPA interrupt Service Routine (HW3). */
/* Arguments : None. */
/* Return Value : None. */
/* Remark : */
/*-----*/
void HW3_ISR(void)
{

}
/*-----*/
/* Function Name: HW4_ISR() */
/* Description : PT1 interrupt Service Routine (HW4). */
/* Arguments : None. */
/* Return Value : None. */
/* Remark : */
/*-----*/
void HW4_ISR(void)
{
    uint32_t PORT_IntFlag;

    PORT_IntFlag=DrvGPIO_GetIntFlag(KEY_PORT);
    if((PORT_IntFlag&KEYIN0)==KEYIN0)
    {
        PT1INTSTATUSbits.b_PTINT1done=1;
    }
    if((PORT_IntFlag&KEYIN1)==KEYIN1)
    {
        PT1INTSTATUSbits.b_PTINT2done=1;
    }
    DrvGPIO_ClearIntFlag(KEY_PORT,KEYIN1|KEYIN0); //clear PT1_1/PT1_2 interrupt flag
}
/*-----*/
/* Function Name: HW5_ISR() */
/* Description : PT2 interrupt Service Routine (HW5). */
/* Arguments : None. */
/* Return Value : None. */
/* Remark : */
/*-----*/
void HW5_ISR(void)
{

}
/*-----*/
/* Function Name: HW7_ISR() */
/* Description : UART2 interrupt Service Routine (HW7). */
/* Arguments : None. */
```

```
/* Return Value : None. */
/* Remark      : */
/*-----*/
void HW7_ISR(void)
{

}
/*-----*/
/* Function Name: HW8_ISR() */
/* Description  : TMB2 interrupt Service Routine (HW8). */
/* Arguments   : None. */
/* Return Value : None. */
/* Remark      : */
/*-----*/
void HW8_ISR(void)
{

}
/*-----*/
/* Function Name: tlb_exception_handler() */
/* Description  : Exception Service Routines. */
/* Arguments   : None. */
/* Return Value : None. */
/* Remark      : */
/*-----*/
void tlb_exception_handler()
{
    asm("nop"); //procedure define by customer.
    asm("nop");
}
/*-----*/
/* Software Delay Subroutines */
/*-----*/
void Delay(unsigned int num)
{
    for(;num>0;num--)
        asm("NOP");
}
/*-----*/
/* End Of File */
/*-----*/
```

20. 修訂記錄

以下描述本檔差異較大的地方，而標點符號與字形的改變不在此描述範圍。

日期	文件版次	頁次	摘要
2014	V01	All	初版發行
2017/1/23	V02	All	修改文件排版風格與文件標題，修改各 IP Demo Code 內容，並且統一程式撰寫風格。
2018/6/15	V03	All	<ul style="list-style-type: none"> - Change the single bin file to separate 3 bin files(APP Bin File/Data Bin File/Bin File) - HY16F198B_ADC : Add HAO 2MHz/4MHz/10MHz/16MHz clock setting. - HY16F198B_GPIO : Modify the GPIO initialization(GPIO setting-->Clear GPIO Flag-->judgement GPIO INT) - HY16F198B_I2C : Modify the I2C_EndFlag judgement - HY16F198B_UART : Modify the UART initialization, avoid to occur the first byte error issue. Modify the demo code application. - HY16F198B_UART2 : Modify the UART2 initialization, avoid to occur the first byte error issue. Modify the demo code application. - HY16F198B_Power : Modify the GPIO initialization(GPIO setting-->Clear GPIO Flag-->judgement GPIO INT) Added the DrvGPIO_PortIDIF judgement before enter sleep or idle mode